

ACCESSORIES 2023

Accessories for industrial vacuum solutions



NILFISK

Accessories for industrial vacuums

Using the right accessory makes easier and efficient your daily work enhancing the performance of your Nilfisk industrial vacuum.

This catalogue allows you to identify the most suitable accessories for all vacuum cleaners and applications. In the tables, you will find the main features of the different accessories, an indication of the sectors where they are recommended to be used and if they are ATEX certified.

A short description of the food, pharma and ATEX range:

Accessories for the food sector:

The color-coded program is one of the main requests of the food sector: each color is matched to a specific production area, in order to avoid any cross contamination or bacteria migration inside the plant. Nilfisk provides a selection of 6 colors of FDA approved accessories for any application. Moreover, a specific range for high temperatures is available, in order to meet any need in ovens cleaning and high temperature material collection, keeping the product quality at the top.

Accessories for the pharmaceutical sector:

Nilfisk accessories for pharmaceutical applications are designed to meet any possible need in terms of safety, hygiene and efficiency. Accessories quality is at the top: FDA certified, the metal parts are made in stainless steel AISI 316L, they can be sterilized placing them in autoclave.

Accessories for vacuum cleaners in ATEX zones

The range of ATEX accessories suitable for II 2D 2G has been developed in order to increase the safety of our industrial vacuums.

Accessories for ACD sector:

Appliance for vacuuming combustible dust. Accessories that are compliant with the industrial application for vacuuming combustible dust. This range includes SS parts, and conductive or antistatic hoses.

How to use the new and certified sequence of ATEX accessories

The ATEX sequence of accessories starts from the inlet which features a hole where to mount the first accessory with a pushbutton. The whole sequence of accessories can be then connected by using male and female parts, along the complete sequence, from the inlet to the final tool. Only accessories with these metal parts will be marked as certified. Here below the marking that all Nilfisk ATEX accessories will feature:

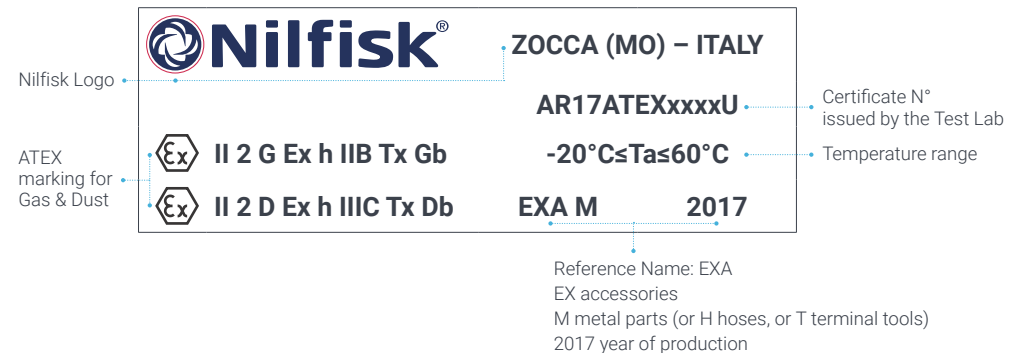

Please feel free to contact us at any time for more details or for the latest information.

+39 059 9730000

industrial-vacuum@nilfisk.com

Note: Images are for reference only. For details please refer to the features in the table.

STANDARD ACCESSORIES VS ATEX / EXA ACCESSORIES



STANDARD ACCESSORIES



ATEX / EXA ACCESSORIES

QUALITY

- Al
- Cr
- Zn
- PVC
- PP
- PTFE
- NBR
- SI
- PU

CONDUCTIVE OR DISSIPATIVE PLASTIC

STAINLESS STEEL

SAFETY

GALVANIZED STEEL OR PLASTIC MATERIALS

NILFISK TAKES RESPONSIBILITY FOR THE CHOICE OF SAFE AND TESTED ACCESSORIES FOR THE OPERATOR

HIGH QUALITY CERTIFIED MATERIALS

COMPLETE SEQUENCE OF ACCESSORIES, FULLY TESTED AND APPROVED BY A CERTIFIED BODY

UNIQUE ACCESSORY ATTACHMENTS AVOID ANY IMPROPER USE OF UNSAFE ACCESSORIES

MARKING INDICATING THE COMPATIBILITY OF SPECIFIC ACCESSORIES TO THE USE WITH ATEX INDUSTRIAL VACUUM

THE OPERATOR IS ONLY IN CONTACT WITH ACCESSORIES SUITABLE FOR USE IN ATEX ENVIRONMENTS



TESTED BY EXTERNAL BODIES



NOT CERTIFIED



THE OPERATOR COULD SUFFER ELECTRICAL SHOCK



THE OPERATOR IS PROTECTED AGAINST ELECTRICAL SHOCK

CERTIFICATION FROM A TEST REPORT PERFORMED BY A THIRD BODY

SAFETY NOT ASSURED IF CONNECTED TO AN ATEX INDUSTRIAL VACUUM

POSSIBILITY TO UPGRADE MACHINES ALREADY IN THE FIELD USING A CONVERSION KIT

ATEX / EXA INDUSTRIAL VACUUMS



ATEX / EXA ACCESSORIES

CONNECTED TO NILFISK ATEX CERTIFIED VACUUM CLEANERS ASSURE SAFETY FROM THE SUCTION POINT: NO TRIGGER RISK

APPLICATIONS

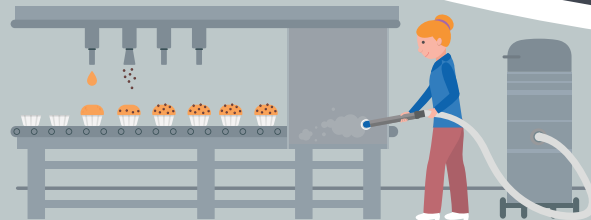

RECOMMENDED FOR STANDARD INDUSTRIAL VACUUMS AND APPLICATIONS











UNIVERSAL, SUITABLE FOR ALL APPLICATIONS EVEN WHERE THERE IS RISK OF EXPLOSION

Key to icons

						
Metal	Food	Pharma/ Chemical	Heavy Industry	General Cleaning	EXA	ACD

Features

							
Oilproof	Conductive (*)	Antistatic (**)	High Temperature	Extremely Flexible	Extremely Light	Autoclavable	Certified 3rd party approval

(*) **Conductive** A conductive hose / sleeve is a hose / sleeve with a volume resistance $< 10^4$ ohm. It may have a conductor built in.

(**) **Antistatic** An antistatic hose is a hose with a volume resistance $< 10^9$ ohm and/or with a conductor built in.

Table of contents

1. Connection diagrams

- 1.a Nilfisk Vacuum cleaner2
- 1.b Nilfisk ATEX Vacuum cleaner4

2. Hoses and Sleeves

- 2.a Hoses6
- 2.b Sleeves 22

3. Hose connectors and Reductions

- 3.a Hose connectors..... 24
- 3.b Reductions 29
- 3.c Examples 36

4. Handgrips and Extensions

- 4.a Handgrips..... 40
- 4.b Examples..... 43

5. Floor nozzles and Brushes

- 5.a Floor nozzles..... 46
- 5.b Brushes..... 52
- 5.c Examples..... 55

6. Final tools

- 6.a Rubber tools..... 58
- 6.b Examples..... 72

7. Accessories Kit 78

Connection Diagrams

1.a Nilfisk Vacuum Cleaner

How to connect Nilfisk accessories to Nilfisk vacuum cleaners.

- | | |
|---|---|
| A See chapter 3
Hose connectors
and Reductions | G See chapter 6.a
Crevice nozzles |
| B See chapter 2.b
Sleeves | H See chapter 5.b
Round brushes |
| C See chapter 2.a
Hoses | I See chapter 6
Final tools |
| D See chapter 4.a
Extensions | J See chapter 5.b
Brushes |
| E See chapter 3.a
Curved connectors | K See chapter 5.a
Nozzles |
| F See chapter 4.a
Handgrips | |

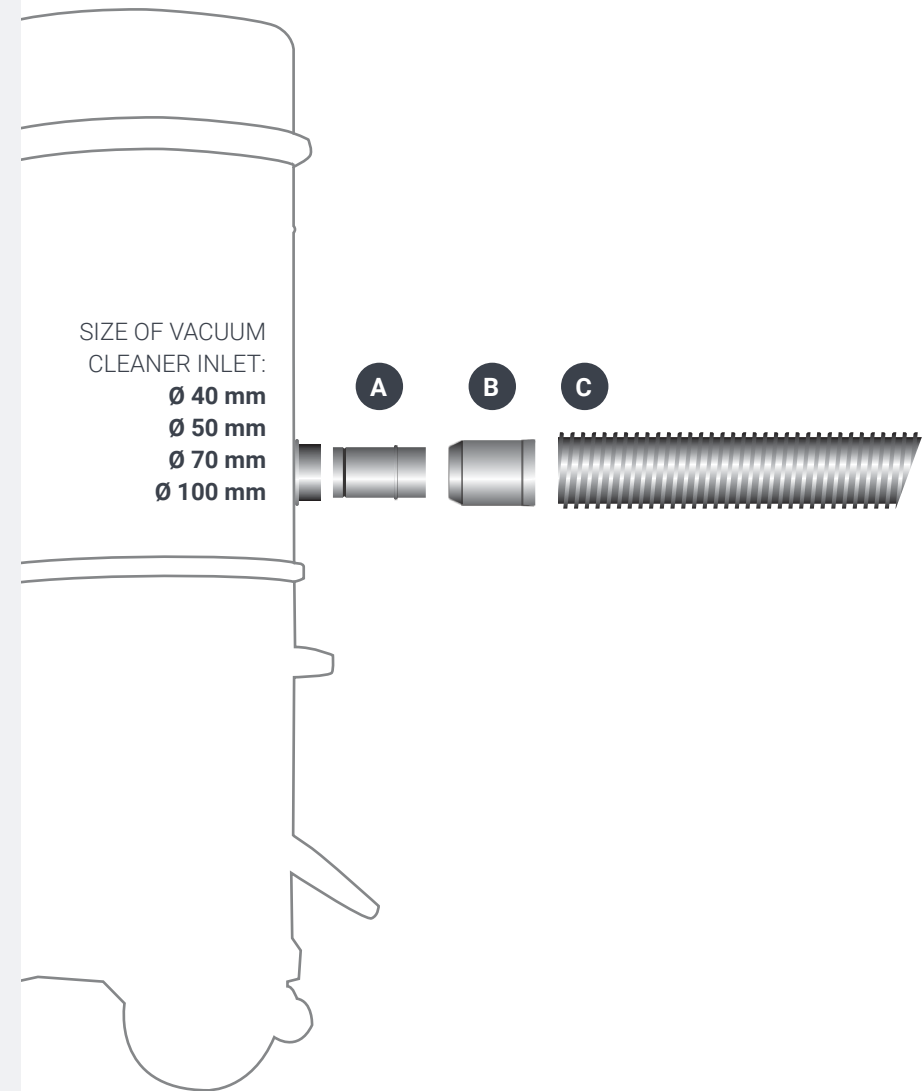

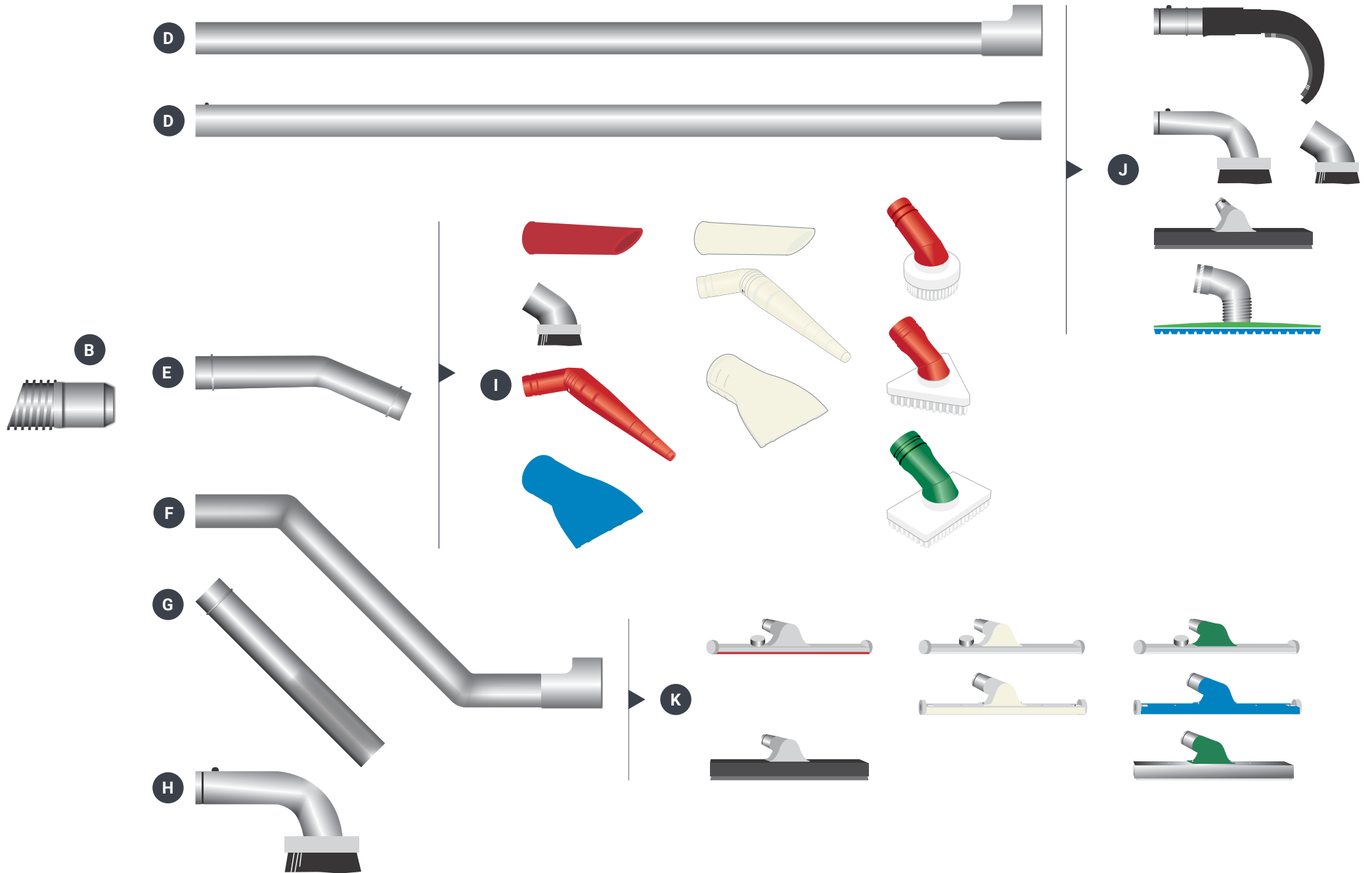

1.b Nilfisk ATEX Vacuum Cleaner

How to connect Nilfisk accessories to Nilfisk vacuum cleaners.

- A** See chapter 7
Inlet
- B** See chapter 2.a
Hoses
- C** See chapter 3.b
Reductions
- D** See chapter 3.b
Bifurcations
- E** See chapter 4.a
Extensions
- F** See chapter 3.a
Curved Connectors
- G** See chapter 4.a
Handgrips
- H** See chapter 6.a
Crevice nozzles
- I** See chapter 5.b
Brushes
- J** See chapter 6
Final tools
- K** See chapter 5.a
Floor nozzles

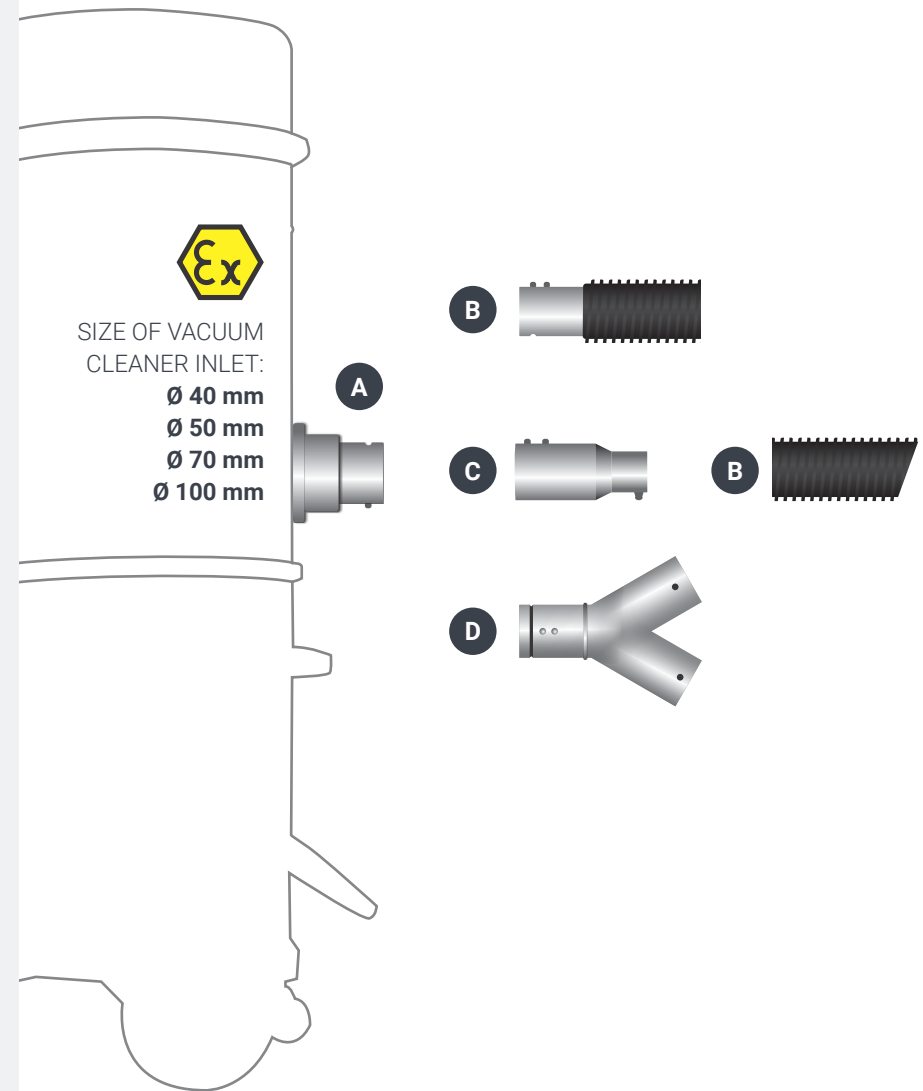

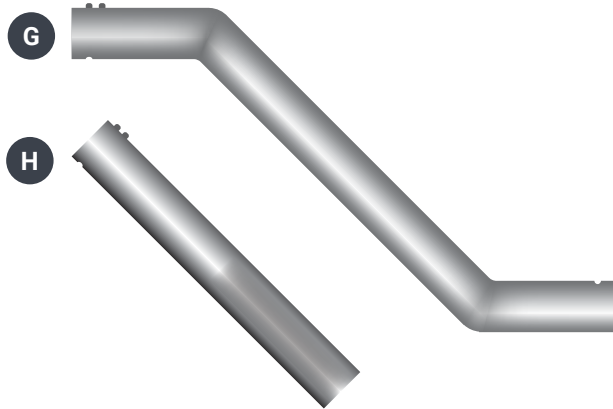
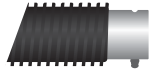

K

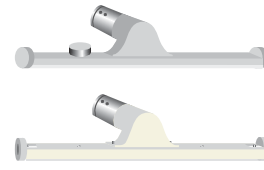

J

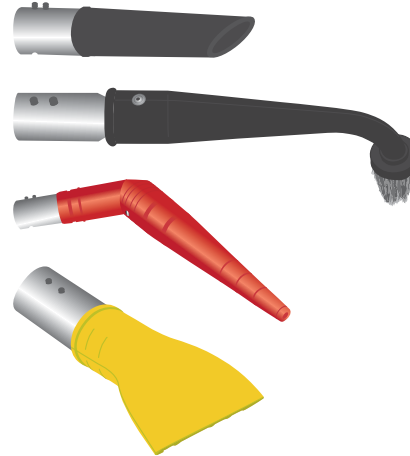

K

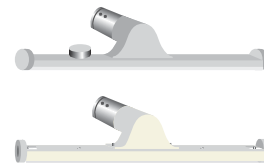

Hoses and Sleeves

This chapter contains tables with the descriptions of the various types of hoses, divided by application, and indications of the sleeves to choose based on the hose used.

Antistatic or conductive hoses can be used for ST1 and ST2 powders.

For ST3 or explosive powders, only the conductive hose can be used.

For ATEX hoses, see details on cleaning and resistance measurement on the ATEX manual.

For EXA hoses, please check the EXA manual for info on periodic checks and to measure accessories.

The last part of the chapter contains useful examples of the connections between hoses and sleeves.

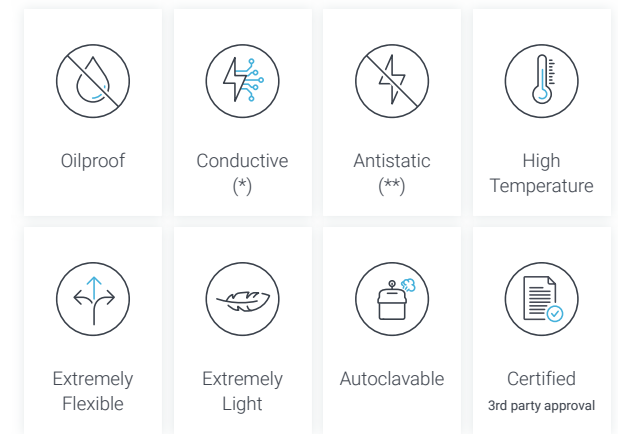

2.a Hoses

FLEX HOSE	Ø mm	Length meters	Material	Sleeves			Code
	40	3	In EVA (ethyl-vinyl-acetate) spiralled and unreinforced + PVC sleeves		• •	•	Z7 22150
		5		included (Z7 23022)	• •	•	Z7 22360
	15			• •	•	4072200469	
	30 complete roll	not included (P/N to order: Z7 23022)		• •	•	4072400231	
	3			• •	•	Z7 22151	
	5	included (Z7 23023)		• •	•	Z7 22361	
	50	15			• •	•	4072200470
	30 complete roll	not included (P/N to order: Z7 23023)		• •	•	4072400232	















The Flex Hose is suitable for cleaning dust and non-abrasive materials. It is a light and flexible grey hose, corrugated both externally and on the inside. Range of temperature: -30°C +60°C.

(*) **Conductive** A conductive hose / sleeve is a hose / sleeve with a volume resistance < 10⁴ ohm. It may have a conductor built in.

(**) **Antistatic** An antistatic hose is a hose with a volume resistance < 10⁹ ohm and/or with a conductor built in.

















AIR HOSE



Ø mm	Length meters	Material	Sleeves																Code	
30	by meter	Plastified PVC hose with rigid PVC spiral + rubber sleeves	N/A																Z8 24023	
	3																		Z7 22049	
	5		included (Z7 20001)																	Z7 22362
	10																			4072200504
	15																			4072200471
	50 complete roll		not included (P/N to order: Z7 20001)																	4072400227
40	3																		Z7 22062	
	5	included (Z7 20002)																	Z7 22363	
	10																		4072200505	
	15																		4072200472	
	50 complete roll	not included (P/N to order: Z7 20002)																	4072400228	
	50	3																		Z7 22063
5		included (Z7 20003)																	Z7 22364	
10																			4072200506	
15																			4072200473	
50 complete roll		not included (P/N to order: Z7 20003)																	4072400229	
70		by meter		not included (P/N to order 4072000362)																Z7 24027
	30 complete roll																		4072400230	
	100																			

The Air Hose is ideal for cleaning dust and non-abrasive materials. It is a light, flexible, grey hose. It is corrugated externally and smooth on the inside. Range of temperature: -10°C +60°C.















HOSES AND SLEEVES – 2.A HOSES

FLEX CONDUCTIVE HOSE	Ø mm	Length meters	Material	Sleeves																Code		
	38/40	3		4072000343	•															4072200509		
		5		4072000343	•																4072200510	
		15		4072000343	•																	4072200602
		30 complete roll		not included (P/N to be ordered 4072000343)	•																	4072400233
50	3	Spiral conductive PE hose with reinforcement on the external spiral with antiabrasion function + conductive polyurethane sleeves	Z7 20325	•																Z7 22375		
	5		Z7 20325	•																	Z7 22377	
	10		Z7 20325	•																		4072200526
	15		Z7 20325	•																		4072200481
	30 complete roll		not included (P/N to be ordered Z7 20325)	•																		4072400234
70	3		4072000348	•																	4072200542	
	5		4072000348	•																		4072200543
	15		not included (P/N to be ordered 4072000348)	•																		4072400261

The Flex hose is a conductive hose made of polyethylene and ethyl-vinyl-acetate (EVA). It is suitable for cleaning dust, non-abrasive materials, and conductive materials. It is black, with a grey line on the ridge; it is flexible and is corrugated externally and smooth on the inside. Range of temperature: -20°C / +60°C

CONDUCTIVE POLYURETHANE HOSE















Ø mm	Length meters	Material	Sleeves																Code	
40	3		40000212	•	•							•			•				Z7 22368	
	5		40000212	•	•								•			•				Z7 22371
	10		40000212	•	•								•			•				Z7 22351
	15		40000212	•	•								•			•				4072200477
50	3	PU conductive flexible, spiral tube with copper-plated steel armor covered in conductive PU + conductive polyurethane sleeves	40000219	•	•							•			•				Z7 22369	
	5		40000219	•	•							•			•				Z7 22372	
	10		40000219	•	•							•			•				Z7 22352	
70	15	40000219	•	•								•			•				4072200478	
	3	Z7 20310	•	•								•			•				Z7 22370	
	5	Z7 20310	•	•								•			•				Z7 22373	
100	15	Z7 20310	•	•								•			•				4072200479	
	by meter	not included (P/N to order Z8 40044 – metal tie)	•	•								•			•				4072400259	

The conductive polyurethane hose can be used for cleaning abrasive materials, conductive materials, and liquids. It is black, highly flexible and is corrugated externally and smooth on the inside. Range of temperature: -30°C / +90°C.

HOSES AND SLEEVES – 2.A HOSES

CONDUCTIVE POLYURETHANE EXA HOSE



Ø mm	Length meters	Material	Sleeves														EXA	ACD	Code		
40	3	Conductive polyurethane hose + Stainless Steel AISI 304 hose connectors	Male and female connectors + heat shrink sleeve	4072400489		
	5			4072400490	
	10			4072400491
	15			4072400492
50	3			4072400493
	5			4072400494
	10			4072400495
	15			4072400496
70	3			4072400497
	5			4072400498
	10			4072400499
	15			4072400500
100	3			4072400501
	5			4072400502
	10			4072400503
	15			4072400504

The conductive polyurethane hose can be used for cleaning abrasive materials, conductive materials, and liquids. It is black, highly flexible and is corrugated externally and smooth on the inside. It is connected with two metal connectors through a rivet and covered by a black heat shrink cover. Metal connectors will be marked according to the type of hose. Range of temperature: -30°C / +90°C.

RUBBER HOSE



Ø mm	Length meters	Material	Sleeves			Code						
40	3	Black conductive smooth rubber with antistatic wire with Green cover	Integrated sleeves	•	•	•	•	•	•	Z7 24005		
	5			•	•	•	•	•	•	Z7 24178		
50	3			•	•	•	•	•	•	Z7 24003		
	5			•	•	•	•	•	•	Z7 24179		
70	3			•	•	•	•	•	•	Z7 24001		
	5			•	•	•	•	•	•	Z7 24180		
50	5			Black corrugated conductive rubber, abrasion resistant	Integrated sleeves	•	•	•	•	•	•	ZA7240005
	10					•	•	•	•	•	•	ZA7240003
70	5					•	•	•	•	•	•	ZA7240015
	10					•	•	•	•	•	•	ZA7240018
100	5	•	•			•	•	•	•	ZA7240011		
	10	•	•			•	•	•	•	ZA7240042		

The rubber oilproof hose is suitable for cleaning metal shavings mixed with traces of oil, dust and conductive materials. It is corrugated externally and smooth on the inside. It has a metal wire to earth the hose resistant to mineral oils. The green cover is square corrugated rubber resistant to abrasion, with fabric impression. Temperature range - 25 °C / +100°C (the corrugated version is up to +70°C).















RUBBER EXA HOSE



Ø mm	Length meters	Material	Sleeves			Code					
40	3	Conductive rubber hose + Stainless Steel AISI 304 hose connectors	Male and female connectors + heat shrink sleeve	•	•	•	•	•	•	4072400483	
	5			•	•	•	•	•	•	4072400484	
50	3			•	•	•	•	•	•	•	4072400485
	5			•	•	•	•	•	•	•	4072400486
70	3			•	•	•	•	•	•	•	4072400487
	5			•	•	•	•	•	•	•	4072400488

The rubber oilproof hose is suitable for cleaning metal shavings mixed with traces of oil, dust and conductive materials. It is corrugated externally and smooth on the inside. It has a metal wire to earth the hose. It is connected with two metal connectors through a rivet and covered by a black heat shrink cover. Metal connectors will be marked according to the type of hose. Temperature range -40°C / +120°C.















HOSES AND SLEEVES – 2.A HOSES

FLEX CONDUCTIVE EXA HOSE	Ø mm	Length meters	Material	Sleeves	             	Code											
	40	3	Abrasion-resistant polyurethane with internal PVC-coated spring steel spiral	Male and female connectors + heat shrink sleeve	4072400451		
		5			4072400452		
		10			4072400453		
		15			4072400454		
	50	3			4072400455
		5			4072400456
		10			4072400457
	70	15			4072400458
		3			4072400667
		5			4072400657
	100	10			4072400668
		15			4072400669
		3			4072400670
		5			4072400671
					10	4072400672
		15	4072400673			

The new Flex conductive hose is a conductive hose made of abrasion resistant polyurethane. It is highly suitable in potentially explosive atmospheres for conveying abrasive solids such as dusts and powders. It is black, very flexible and light. It is corrugated externally and smooth on the inside. It will resist from -40°C to +90°C. It is connected with two metal connectors through a rivet and covered by a black heat shrink cover. Metal connectors will be marked according to the type of hose.

POLYURETHANE HOSE



Ø mm	Length meters	Material	Sleeves	              	Code		
40	3	Polyurethane hose with steel spiral + polyurethane sleeves	40000212	.	.	.	Z7 22297
	5		40000212	.	.	.	Z7 22365
	15		40000212	.	.	.	4072200474
50	3		40000219	.	.	.	Z7 22298
	5		40000219	.	.	.	Z7 22366
	10		40000219	.	.	.	4072400437
	15		40000219	.	.	.	4072200475
70	3		Z7 20310	.	.	.	Z7 22299
	5		Z7 20310	.	.	.	Z7 22367
	15		Z7 20310	.	.	.	4072200476
100	sold by meter, max 15 m		not included (P/N to order Z8 40044 – metal tie)	.	.	.	Z7 24113

The polyurethane hose is suitable for cleaning abrasive materials and liquids. It is transparent with a grey spiral. It is corrugated externally and smooth on the inside. It also has a steel spiral to be connected properly. The hose must be installed so the small arrow on the outside is pointing towards the inlet of the vacuum cleaner. Range of temperature: -40°C / +90°C.

HOSES AND SLEEVES – 2.A HOSES

FLEX ANTISTATIC EXA HOSE



Ø mm	Length meters	Material	Sleeves			Code									
40	3	PVC with coated spring steel spiral + Stainless Steel AISI 304 hose connectors	Male and female connectors + heat shrink sleeve	<input type="checkbox"/>	<input type="checkbox"/>	<input type="checkbox"/>	<input type="checkbox"/>	<input type="checkbox"/>	<input type="checkbox"/>	<input type="checkbox"/>	<input type="checkbox"/>	<input type="checkbox"/>	4072400459		
	5			<input type="checkbox"/>	<input type="checkbox"/>	<input type="checkbox"/>	<input type="checkbox"/>	<input type="checkbox"/>	<input type="checkbox"/>	<input type="checkbox"/>	<input type="checkbox"/>	<input type="checkbox"/>	4072400460		
	10			<input type="checkbox"/>	<input type="checkbox"/>	<input type="checkbox"/>	<input type="checkbox"/>	<input type="checkbox"/>	<input type="checkbox"/>	<input type="checkbox"/>	<input type="checkbox"/>	<input type="checkbox"/>	<input type="checkbox"/>	4072400461	
	15			<input type="checkbox"/>	<input type="checkbox"/>	<input type="checkbox"/>	<input type="checkbox"/>	<input type="checkbox"/>	<input type="checkbox"/>	<input type="checkbox"/>	<input type="checkbox"/>	<input type="checkbox"/>	<input type="checkbox"/>	4072400462	
50	3			<input type="checkbox"/>	<input type="checkbox"/>	<input type="checkbox"/>	<input type="checkbox"/>	<input type="checkbox"/>	<input type="checkbox"/>	<input type="checkbox"/>	<input type="checkbox"/>	<input type="checkbox"/>	<input type="checkbox"/>	<input type="checkbox"/>	4072400463
	5			<input type="checkbox"/>	<input type="checkbox"/>	<input type="checkbox"/>	<input type="checkbox"/>	<input type="checkbox"/>	<input type="checkbox"/>	<input type="checkbox"/>	<input type="checkbox"/>	<input type="checkbox"/>	<input type="checkbox"/>	<input type="checkbox"/>	4072400464
	10			<input type="checkbox"/>	<input type="checkbox"/>	<input type="checkbox"/>	<input type="checkbox"/>	<input type="checkbox"/>	<input type="checkbox"/>	<input type="checkbox"/>	<input type="checkbox"/>	<input type="checkbox"/>	<input type="checkbox"/>	<input type="checkbox"/>	4072400465
	15			<input type="checkbox"/>	<input type="checkbox"/>	<input type="checkbox"/>	<input type="checkbox"/>	<input type="checkbox"/>	<input type="checkbox"/>	<input type="checkbox"/>	<input type="checkbox"/>	<input type="checkbox"/>	<input type="checkbox"/>	<input type="checkbox"/>	4072400466
70	3			<input type="checkbox"/>	<input type="checkbox"/>	<input type="checkbox"/>	<input type="checkbox"/>	<input type="checkbox"/>	<input type="checkbox"/>	<input type="checkbox"/>	<input type="checkbox"/>	<input type="checkbox"/>	<input type="checkbox"/>	<input type="checkbox"/>	4072400674
	5			<input type="checkbox"/>	<input type="checkbox"/>	<input type="checkbox"/>	<input type="checkbox"/>	<input type="checkbox"/>	<input type="checkbox"/>	<input type="checkbox"/>	<input type="checkbox"/>	<input type="checkbox"/>	<input type="checkbox"/>	<input type="checkbox"/>	4072400675
	10			<input type="checkbox"/>	<input type="checkbox"/>	<input type="checkbox"/>	<input type="checkbox"/>	<input type="checkbox"/>	<input type="checkbox"/>	<input type="checkbox"/>	<input type="checkbox"/>	<input type="checkbox"/>	<input type="checkbox"/>	<input type="checkbox"/>	4072400676
100	3			<input type="checkbox"/>	<input type="checkbox"/>	<input type="checkbox"/>	<input type="checkbox"/>	<input type="checkbox"/>	<input type="checkbox"/>	<input type="checkbox"/>	<input type="checkbox"/>	<input type="checkbox"/>	<input type="checkbox"/>	<input type="checkbox"/>	4072400678
	5	<input type="checkbox"/>	<input type="checkbox"/>	<input type="checkbox"/>	<input type="checkbox"/>	<input type="checkbox"/>	<input type="checkbox"/>	<input type="checkbox"/>	<input type="checkbox"/>	<input type="checkbox"/>	<input type="checkbox"/>	<input type="checkbox"/>	4072400679		
	10	<input type="checkbox"/>	<input type="checkbox"/>	<input type="checkbox"/>	<input type="checkbox"/>	<input type="checkbox"/>	<input type="checkbox"/>	<input type="checkbox"/>	<input type="checkbox"/>	<input type="checkbox"/>	<input type="checkbox"/>	<input type="checkbox"/>	4072400680		

The new flex antistatic hose is made with PVC with a coated steel spiral that is properly grounded and connected to metal hose connectors to guarantee the continuity. It is suitable for cleaning abrasive materials and liquids. It is very flexible and light. It is slightly corrugated externally but with a PVC cover and smooth on the inside. Range of temperature: from 0°C to +85°C It is connected with two metal connectors through a rivet and covered by a black heat shrink cover. Metal connectors will be marked according to the type of hose.

ANTISTATIC NON TOXIC HOSE

















Ø mm	Length meters	Material	Sleeves			Code									
30	sold by meter	PVC hose with rigid PVC spiral and underlay in transparent polyurethane and copper wire	not included (P/N to order Z8 40040 or Z8 40044 – metal ties)	<input type="checkbox"/>	<input type="checkbox"/>	<input type="checkbox"/>	<input type="checkbox"/>	<input type="checkbox"/>	<input type="checkbox"/>	<input type="checkbox"/>	<input type="checkbox"/>	<input type="checkbox"/>	Z7 24054		
40				<input type="checkbox"/>	<input type="checkbox"/>	<input type="checkbox"/>	<input type="checkbox"/>	<input type="checkbox"/>	<input type="checkbox"/>	<input type="checkbox"/>	<input type="checkbox"/>	<input type="checkbox"/>	<input type="checkbox"/>	Z7 24028	
50				<input type="checkbox"/>	<input type="checkbox"/>	<input type="checkbox"/>	<input type="checkbox"/>	<input type="checkbox"/>	<input type="checkbox"/>	<input type="checkbox"/>	<input type="checkbox"/>	<input type="checkbox"/>	<input type="checkbox"/>	<input type="checkbox"/>	Z7 24029
70				<input type="checkbox"/>	<input type="checkbox"/>	<input type="checkbox"/>	<input type="checkbox"/>	<input type="checkbox"/>	<input type="checkbox"/>	<input type="checkbox"/>	<input type="checkbox"/>	<input type="checkbox"/>	<input type="checkbox"/>	<input type="checkbox"/>	Z7 24030
100				<input type="checkbox"/>	<input type="checkbox"/>	<input type="checkbox"/>	<input type="checkbox"/>	<input type="checkbox"/>	<input type="checkbox"/>	<input type="checkbox"/>	<input type="checkbox"/>	<input type="checkbox"/>	<input type="checkbox"/>	<input type="checkbox"/>	Z7 24069

The non-toxic anti-static hose is suitable for cleaning abrasive and granular materials, it is corrugated on the outside and smooth inside. It is suitable for contact with food products as it is FDA approved. It also has a metal spiral to be connected properly. Range of temperature: from -10°C to +60°C.

SILICONE HOSE

















Ø mm	Length meters	Material	Sleeves																Code	
40	sold by meter	White silicone hose with Stainless Steel wire	not included																	Z7 24189
50																				

The silicone hose is designed for cleaning powder from foodstuffs and pharmaceutical mixtures (FDA approved). It is white, resistant to high temperatures (up to 200°C) and therefore can be sterilized in autoclave (at 121°C). It has a stainless steel spiral to earth the hose; it is smooth on the inside and slightly smooth externally. Range of temperature: -60°C to +200°C.

SILICONE EXA HOSE



Ø mm	Length meters	Material	Sleeves																Code			
40	3	White silicone hose with Stainless Steel wire + Stainless Steel AISI 304 hose connectors	Male and female connectors + heat shrink sleeve																	4072400475		
	5																				4072400476	
10																					4072400477	
15																					4072400478	
50	3																					4072400479
	5																					4072400480
	10																					4072400481
	15																			4072400482		

The silicone hose is designed for cleaning powder from foodstuffs and pharmaceutical mixtures (FDA approved). It is white, resistant to high temperatures (up to 200°C) and therefore can be sterilized in autoclave (at 121°C). It has a stainless steel spiral to earth the hose; it is smooth on the inside and slightly smooth externally. It is connected with two metal connectors through a rivet and covered with a white heat shrink cover. Metal connectors will be marked according to the type of hose. Range of temperature: -60°C to +200°C.

SMOOTH SILICONE HOSE





Ø mm	Length meters	Material	Sleeves																Code			
40	3	White silicone hose with Stainless Steel wire	Integrated sleeves																	4072100135		
	5																				4072100137	
50	3																					4072100136
	5																					4072100138

The silicone hose is designed for cleaning powder from foodstuffs and pharmaceutical mixtures (FDA approved). It is white, resistant to high temperatures (up to 200°C) and therefore can be sterilized in autoclave (at 121°C). It has a stainless steel spiral to earth the hose; it is smooth both on the inside and externally. Range of temperature: -60°C to +200°C.

HOSES AND SLEEVES – 2.A HOSES

TRANSPARENT FDA HOSE



∅ mm	Length meters	Material	Sleeves																Code	
40	3	Transparent polyurethane FDA hose with steel wire + FDA approved white sleeves	4072000358																4072400334	
	5		4072000358																4072400336	
	10		4072000358																	4072400338
	15		4072000358																	4072400414
50	3		4072000359																	4072400335
	5		4072000359																	4072400337
	10		4072000359																	4072400339
	15		4072000359																	4072400415

The transparent antistatic hose is the most suitable for the Food & Pharma sectors. It is made with FDA approved material, it is compliant with European Regulations 1935/2004/CE. It is very flexible and light. It is transparent in order to guarantee a better visual check. In case of usage in ATEX environment, the hose has to be connected properly. Temperature range: -40°C / +90°C.

TRANSPARENT ANTISTATIC FDA HOSE















∅ mm	Length meters	Material	Sleeves																Code			
40	3	Transparent polyurethane FDA hose with steel wire + FDA approved white sleeves + assembled grounding plates	4072000358																	4072400438		
	5		4072000358																		4072400440	
	10		4072000358																		4072400442	
	15		4072000358																		4072400444	
50	3		4072000359																			4072400439
	5		4072000359																			4072400441
	10		4072000359																			4072400443
	15		4072000359																			4072400445
70	10	4072000435																		4072400726		

The transparent antistatic hose is the most suitable for the Food & Pharma sectors. It is made with FDA approved material, it is compliant with European Regulations 1935/2004/CE. It is very flexible and light. It is transparent in order to guarantee a better visual check. The ground continuity can be guaranteed only by connecting the steel spiral properly so with already assembled grounding plates. Temperature range: -40°C / +90°C.

TRANSPARENT ANTISTATIC
FDA EXA HOSE















Ø mm	Length meters	Material	Sleeves														EXA	ACD	Code			
40	3	Transparent antistatic polyurethane with steel wire + Stainless Steel AISI 304 hose connectors	Male and female connectors + heat shrink sleeve	4072400467		
	5			4072400468	
	10			4072400469
	15			4072400470
50	3			4072400471
	5			4072400472
	10			4072400473
	15			4072400474
70	3			4072400643
	5			4072400644
	10			4072400645
	15			4072400646
100	3			4072400647
	5			4072400648
	10			4072400649
	15	4072400650		

The transparent antistatic hose is the most suitable for the Food & Pharma sectors. It is made with FDA approved material, it is compliant with European Regulations 1935/2004/CE. It is very flexible and light. It is transparent in order to guarantee a better visual check. It is connected with two metal connectors through a rivet and covered with a white heat shrink cover. Metal connectors will be marked according to the type of hose. Temperature range: -40°C / +90°C.

FDA RUBBER HOSE

















Ø mm	Length meters	Material	Sleeves														EXA	ACD	Code	
40	3	White FDA NBR with blue cover	Integrated sleeves	4072400202
50	3		

Light and flexible hose suitable for food applications.

HOSES AND SLEEVES – 2.A HOSES

STEEL HOSE



Ø mm	Length meters	Material	Sleeves	              	Code			
40	3	Flexible galvanized steel hose	D50/40 reduction and 40l/40E hose connector included	Z7 22378
	5		D50/40 reduction and 40l/40E hose connector included	4072200556
	3		D70/40 reduction and 40l/40E hose connector included	4072200532
	5		D70/40 reduction and 40l/40E hose connector included	4072200555
50	3	D70/50 reduction and 50l/50E hose connector included	Z7 22379	
	1		4072400417	
	3		4072400421	
	5		4072400425	
	10		4072400429	
70	15		4072400433	
	1		4072400418	
	3		4072400422	
	5		4072400426	
	10		4072400430	
100	15		4072400434	
	1		4072400419	
	3		4072400423	
	5		4072400427	
	10		4072400431	
150	15		4072400435	
	1		4072400420	
	3		4072400424	
	5		4072400428	
	10		4072400432	
200	15		4072400436	
	15		4072400436	

The steel hose is recommended for cleaning incandescent and highly-abrasive materials. It is corrugated both externally and on the inside. The 3 m version with metal reductions included should be used with extensions that have the harmonic spring coupling (see chapter 4.b). For hoses by meter, metal reductions are not included. The hose can resist up to 500°C.

FLEXIBLE HIGH TEMPERATURE HOSE



∅ mm	Length meters	Material	Sleeves		Code																
40	3	Premium high temperature polyurethane with spring steel wire firmly embedded in wall	included (P/N for replacement Z8 40932 for D40, Z8 40042 for D50 – metal ties)	4072400736		
	5			4072400752	
	10			4072400753
	15			4072400754
50	3			4072400755
	5			4072400756
	10			4072400757
	15			4072400758

The high temperature hose meets any need in ovens cleaning and high temperature material collection. It is corrugated inside and outside, and very flexible and light. It can resist up to 150°C.

HOSES FOR IVT1000



∅ mm	Length meters	Material	Sleeves		Code														
		Plastic hose with plastic sleeves		80553100
			L01716100																
32	3	Conductive hose with conductive sleeves		80552900
		Silicone hose with Stainless Steel ties	Integrated sleeves	80551900

These hoses are designed specifically for the IVT1000: The grey plastic hose is very flexible and light. It is corrugated externally and smooth on the inside. The black conductive hose is very flexible and light. It is conductive, corrugated externally and on the inside. These 2 hoses are suitable for cleaning dust and non-abrasive materials. The white silicone hose is highly flexible, lightweight and smooth both on the inside and externally. It is ideal for cleaning pharmaceutical powders and mixtures (FDA approved), as it can also be sterilized in an autoclave (at 121°C).

HOSES AND SLEEVES – 2.A HOSES

CONNECTION EXA HOSES



For technical specifications, please refer to the dedicated table in previous pages according to the name of the hose.

CONNECTION EXA HOSES	Ø mm	Length meters	Material	Sleeves		Code													
FLEX CONDUCTIVE HOSE: Abrasion-resistant polyurethane with internal PVC-coated spring steel spiral + Stainless Steel AISI 304 hose connector	40	5			•	•	•	•	•	•	•	•	•	•	•	4072400640			
	50	5			•	•	•	•	•	•	•	•	•	•	•	•	•	4072400710	
	40	3			•	•	•	•	•	•	•	•	•	•	•	•	•	4072400624	
		5			•	•	•	•	•	•	•	•	•	•	•	•	•	4072400625	
		10			•	•	•	•	•	•	•	•	•	•	•	•	•	4072400626	
		15			•	•	•	•	•	•	•	•	•	•	•	•	•	4072400627	
		3			•	•	•	•	•	•	•	•	•	•	•	•	•	4072400628	
	50	5			•	•	•	•	•	•	•	•	•	•	•	•	•	4072400629	
		10			•	•	•	•	•	•	•	•	•	•	•	•	•	4072400630	
		15			•	•	•	•	•	•	•	•	•	•	•	•	•	4072400631	
		70			3	•	•	•	•	•	•	•	•	•	•	•	•	•	4072400632
					5	•	•	•	•	•	•	•	•	•	•	•	•	•	4072400633
	10				•	•	•	•	•	•	•	•	•	•	•	•	•	4072400634	
	100	15			•	•	•	•	•	•	•	•	•	•	•	•	•	4072400635	
		3			•	•	•	•	•	•	•	•	•	•	•	•	•	4072400636	
5		•	•	•	•	•	•	•	•	•	•	•	•	•	4072400637				
10		•	•	•	•	•	•	•	•	•	•	•	•	•	4072400638				
15		•	•	•	•	•	•	•	•	•	•	•	•	•	4072400639				
CONDUCTIVE POLYURETHANE HOSE: Conductive polyurethane hose + Stainless Steel AISI 304 hose connector	40	3	•	•	•	•	•	•	•	•	•	•	•	•	•	4072400616			
		5	•	•	•	•	•	•	•	•	•	•	•	•	•	4072400617			
		10	•	•	•	•	•	•	•	•	•	•	•	•	•	4072400618			
		15	•	•	•	•	•	•	•	•	•	•	•	•	•	4072400619			

CONNECTION EXA HOSES





















For technical specifications, please refer to the dedicated table in previous pages according to the name of the hose.









Ø mm	Length meters	Material	Sleeves		Code
50	3	CONDUCTIVE POLYURETHANE HOSE: Conductive polyurethane hose + Stainless Steel AISI 304 hose connector		• • • • • • • • • • • • • • • •	4072400620
	5			• • • • • • • • • • • • • • • •	4072400621
	10			• • • • • • • • • • • • • • • •	4072400622
	15			• • • • • • • • • • • • • • • •	4072400623
70	3		Male connector + heat shrink sleeve	• • • • • • • • • • • • • • • •	4072400604
	5			• • • • • • • • • • • • • • • •	4072400610
	10			• • • • • • • • • • • • • • • •	4072400611
100	15			• • • • • • • • • • • • • • • •	4072400660
	5			• • • • • • • • • • • • • • • •	4072400666
	5			• • • • • • • • • • • • • • • •	4072400707
50	5	RUBBER HOSE: Smooth black conductive rubber, abrasion resistant		• • • • • • • • • • • • • • • •	4072400725
	8	FLEX ANTISTATIC HOSE: PVC with coated spring steel spiral + Stainless Steel AISI 304 hose connectors		• • • • • • • • • • • • • • • •	4072400725

The connection hoses are made up of 1 male connection and the hose. It has an open bottom. It can be used to connect the hose with an EXA machine and on the other side you can connect the overhead cleaning kit (see page 90), the processing machines of the customer, or separators.

2.a Hoses

PVC SLEEVES	∅ mm	Material									EXA	ACD	COLOUR	CODE
	40	PVC												Z7 23022
	50												GREY	Z7 23023
The rigid, grey PVC sleeve connects to the Flex hose.														

RUBBER SLEEVES	∅ mm	Material									EXA	ACD	COLOUR	CODE
	40	RUBBER												Z7 20001
	50												BLACK	Z7 20002
	70													Z7 20003
The black rubber sleeve connects to the Air hose.														

POLYURETHANE SLEEVES	∅ mm	Material									EXA	ACD	COLOUR	CODE
	40	CONDUCTIVE POLYURETHANE												40000212
	50												BLACK	40000219
	70													Z7 20310
The black polyurethane sleeve is conductive. This sleeve is designed specifically for the polyurethane hose and the conductive polyurethane hose.														

POLYURETHANE SLEEVES



∅ mm	Material									EXA	ACD	COLOUR	CODE
38/40	CONDUCTIVE POLYURETHANE	.											4072000343
50		.										BLACK	Z7 20325
70		.											4072000348

The black polyurethane sleeve is conductive. This sleeve connects to the Flex conductive hose.

FDA COLOURED POLYURETHANE SLEEVES



∅ mm	Material									EXA	ACD	COLOUR	CODE
40	FDA POLYURETHANE	.										WHITE	4072000358
		.										BLUE	4072000363
		.										YELLOW	4072000364
		.										RED	4072000365
		.										GREEN	4072000366
		.										WHITE	4072000359
		.										BLUE	4072000367
		.										YELLOW	4072000368
50	FDA POLYURETHANE	.										RED	4072000369
		.										GREEN	4072000370

The white FDA polyurethane sleeve is designed for the antistatic FDA transparent hose. Coloured versions are available.

Hose connectors and Reductions

Thanks to the range of hose connectors, reductions, bifurcations and trifurcations, the users can find the most appropriate combinations to meet their needs.

You can fit several sections of hose together quickly, to reach various parts of the environment at the same time, or connect Nilfisk hoses to old Nilfisk vacuum cleaners.

Some of the most common example connections can be found at the end of the chapter.

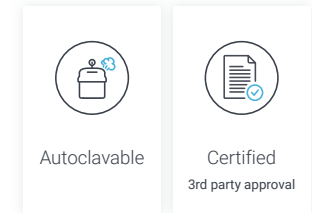

3.a Hose connectors

HOSE FITTING	∅ mm	MATERIAL										COLOR	NOTES	CODE
	40	ZINC-PLATED			•			•	•				2 external flanges	Z7 21005
		STAINLESS STEEL AISI 304	•		•			•	•					Z7 22229
						•						BLUE		4072400348
						•						RED		4072400349
		STAINLESS STEEL AISI 316L + COLOURED SILICONE RING	•		•							YELLOW		4072400350
						•						WHITE		4072400351
				•							GREEN	4072400352		
	50	ZINC-PLATED			•			•	•				1 internal flange and 1 external flange	Z7 21003
		STAINLESS STEEL AISI 304	•		•			•	•					Z7 22230
		STAINLESS STEEL AISI 316L	•		•			•	•					4072100139
						•						BLUE		4072400353
		STAINLESS STEEL AISI 316L + COLOURED SILICONE RING	•		•							RED		4072400354
						•						YELLOW		4072400355
				•							WHITE	4072400356		
				•							GREEN	4072400357		
70	70	ZINC-PLATED			•			•	•				Z7 21001	
		STAINLESS STEEL AISI 304	•		•			•	•				Z7 22231	
		STAINLESS STEEL AISI 316L	•		•			•	•				4072100187	
100	100	ZINC-PLATED			•			•	•			Z7 21040		
		STAINLESS STEEL AISI 304	•		•			•	•				Z7 22232	









The hose fitting is an element that lets you connect a hose to any Nilfisk vacuum cleaner that has a quick-fit inlet. Coloured versions have an internal flange with a coloured silicone ring.

JOINT/ REDUCER FOR WALL
INLET EXA

	Ø mm	MATERIAL	 	    	EXA	ACD	COLOR	NOTES	CODE
	50		• •	• • • • • •					4578300103
	70		• •	• • • • • •					4578300102
	50/40	STAINLESS STEEL AISI 304	• •	• • • • • •				Hole for the EXA connection	4578300100
	70/50		• •	• • • • • •					4578300101
	100/70		• •	• • • • • •					4578300104

These joints and reducers have been developed to connect all EXA certified accessories to the wall inlet of fixed pipings.

 HOSE FITTING WITH FLOW
REGULATOR

	Ø mm	MATERIAL	 	    	EXA	ACD	COLOR	NOTES	CODE
	50	ZINC-PLATED		• • •					Z7 22058
		STAINLESS STEEL AISI 304	•	• • • • •					Z7 22221
	70	ZINC-PLATED			• • •				Z7 22113
		STAINLESS STEEL AISI 304	•	• • • • •				1 internal flange and 1 external flange	Z7 22222
		STAINLESS STEEL AISI 316 L	•	• • • • •					4072200746
	100	ZINC-PLATED			• • •				Z7 22144
		STAINLESS STEEL AISI 304	•	• • • • •					Z7 22206
	40		• •	• • • • •					4072400723
	50	STAINLESS STEEL AISI 304	• •	• • • • •					4072400720
	70		• •	• • • • •					4072400682
100	• •		• • • • •					4072400721	

The hose fitting with flow regulator is a special hose connector which, as well as connecting the hose to a Nilfisk vacuum cleaner, lets you regulate the vacuum power by hand.

HOSE CONNECTORS AND REDUCTIONS – 3.A HOSE CONNECTORS













ADAPTER	∅ mm	MATERIAL		COLOR	NOTES	CODE
	38/40	ZINC-PLATED AND CHROMED COMPONENTS			To be used to connect an old Nilfisk machine having the bayonet connection inlet to a Nilfisk IVS hose	Z7 22380
	50/40					Z7 22381
	50/50					Z7 22382
	38/40	ZINC-PLATED			1 external flange and a ball to connect to bayonet coupling, code 22329900	Z7 22355
	50/40				1 external flange and a ball to connect to bayonet coupling, code 22344200	Z7 22356
	50/50				Z7 22357	
	38	CHROMED			Only for old Nilfisk machines having the bayonet connection inlet	22329900
	50				22344200	

The bayonet coupling adaptor is used to connect an old Nilfisk vacuum cleaner with a Nilfisk hose. An adapter for the Nilfisk bayonet fitting and bayonets only is also available. The bayo adapter is suitable for old Nilfisk machines having the bayonet connection inlet.

JUNCTION FITTING	∅ mm	MATERIAL		COLOR	NOTES	CODE	
	40	ZINC-PLATED				Z7 21004	
		STAINLESS STEEL AISI 304				Z7 22240	
		STAINLESS STEEL AISI 316L				4072100140	
	50	ZINC-PLATED				Z7 21002	
		STAINLESS STEEL AISI 304				Z7 22241	
		STAINLESS STEEL AISI 316L				4072100141	
		STAINLESS STEEL AISI 316L + COLOURED SILICONE RING				BLUE	4072400343
						RED	4072400344
						YELLOW	4072400345
						WHITE	4072400346
	GREEN	4072400347					
	70	ZINC-PLATED				Z7 21000	
		STAINLESS STEEL AISI 304				Z7 22242	
	100	ZINC-PLATED				Z7 21041	

The junction fitting is a component used to connect two hoses or a hose and a rubber or plastic accessory/tool. The diameters of the components are the same. Coloured versions have an internal flange with a coloured silicone ring.

BENT FITTING

	∅ mm	MATERIAL	 	       	EXA	ACD	COLOR	NOTES	CODE	
	40	ZINC-PLATED		.	.	.			Z7 21013	
		STAINLESS STEEL AISI 304		Z7 21033	
		STAINLESS STEEL AISI 316L		4072100145	
			BLUE		4072400373
			RED	2 external flanges	4072400374
		STAINLESS STEEL AISI 316L + COLOURED SILICONE RING	YELLOW		4072400375
			WHITE		4072400376
			GREEN		4072400377
		STAINLESS STEEL AISI 304			4072100160
			50	ZINC-PLATED		.	.	.		
STAINLESS STEEL AISI 304		Z7 21034	
STAINLESS STEEL AISI 316L		4072100146	
	BLUE		4072400378
	RED	2 external flanges	4072400379
STAINLESS STEEL AISI 316L + COLOURED SILICONE RING	YELLOW		4072400380
	WHITE		4072400381
	GREEN		4072400382
STAINLESS STEEL AISI 304			4072100161
70	ZINC-PLATED					.	.	.		
	STAINLESS STEEL AISI 304		2 external flanges	4072100099	

The curved fitting is a component used to fit a hose to a rubber or plastic accessory/tool. It is often used when you have to clean places that are hard to reach.
The curved fitting with reduction is a special version of this component. Coloured versions have an internal flange with a coloured silicone ring.

HOSE CONNECTORS AND REDUCTIONS – 3.A HOSE CONNECTORS

BENT FITTING WITH REDUCTION









Ø mm	MATERIAL	 	    	EXA	ACD	COLOR	NOTES	CODE
40/32	STAINLESS STEEL AISI 304	•	•	•	•			4072200693
40/38	ZINC-PLATED		•	•	•			Z7 22358
	STAINLESS STEEL AISI 304	•	•	•	•		1 external flange	Z7 22359
50/40	ZINC-PLATED		•	•	•			Z7 22015
70/50		•	•	•	•			Z7 22153

The curved fitting is a component used to fit a hose to a rubber or plastic accessory/tool. It is often used when you have to clean places that are hard to reach. The curved fitting with reduction is a special version of this component. Coloured versions have an internal flange with a coloured silicone ring.

QUICK-FIT FITTING







Ø mm	MATERIAL	 	    	EXA	ACD	COLOR	NOTES	CODE
40	ZINC-PLATED		•	•	•			Z7 22186
50		•	•	•	•		1 quick-fit fitting, 1 external flange	Z7 22187
70		•	•	•	•			Z7 22188

The quick-fit fitting is a simple and quick connector to use between two hoses or a hose and a rubber tool. The quick-fit fitting is always used with a hose connector or, if necessary, a reduction. The diameters of the components may be different.











EXTENSION FITTING WITH PIN



Ø mm	MATERIAL	 	    	EXA	ACD	COLOR	NOTES	CODE
40/38	ZINC-PLATED		•	•	•		1 internal flange, 1 quick-fit coupling with harmonic spring, 1 external flange. To use as a connecting element between quick-fit extensions with harmonic springs and coloured floor nozzles and brushes (50 mm diameter)	4072200389
50/40		•	•	•	•		1 quick-fit coupling with harmonic spring. To use as a connecting element between quick-fit extensions with harmonic springs and round brushes (38 mm diameter)	4072200387
50		•	•	•	•		1 internal flange, 1 quick-fit coupling with harmonic spring, 1 external flange. To use as a connecting element between quick-fit extensions with harmonic springs and coloured floor nozzles and brushes (50 mm diameter)	4072200388
40/38		•	•	•	•		Lets you fit the old Nilfisk tools	4072200390

The extension fitting is a special fitting used to connect quick-fit extensions with harmonic springs to specific final accessories/tools. In particular, the extension fitting with reduction (code 4072200390), assembled on the 40 mm diameter curved fitting, lets you fit 38 mm diameter old Nilfisk tools.

3.b Reduction

REDUCTION	∅ mm	MATERIAL	 	     	EXA	ACD	COLOR	NOTES	CODE	
	40/32	STAINLESS STEEL AISI 304	•	•	•	•	•		1 internal flange, 1 external flange	Z7 22347
		STAINLESS STEEL AISI 304	•	•	•	•	•		3 external rims	4072200622
	50/32	ZINC-PLATED		•	•	•	•			Z7 22313
		STAINLESS STEEL AISI 304	•	•	•	•	•			Z7 22346
		ZINC-PLATED		•	•	•	•			Z7 22000
		STAINLESS STEEL AISI 304	•	•	•	•	•			Z7 22223
	50/40	STAINLESS STEEL AISI 316L	•	•	•	•	•		1 internal flange, 1 external flange	4072100142
			•	•	•	•	•	BLUE		4072400358
			•	•	•	•	•	RED		4072400359
		STAINLESS STEEL AISI 316L + COLOURED SILICONE RING	•	•	•	•	•	YELLOW		4072400360
			•	•	•	•	•	WHITE		4072400361
		•	•	•	•	•	GREEN	4072400362		
		STAINLESS STEEL AISI 304	•	•	•	•	•			4072100153
		STAINLESS STEEL AISI 304 + COLOURED SILICONE RING	•	•	•	•	•	RED		4072200725
		ZINC-PLATED		•	•	•	•			Z7 22002
		STAINLESS STEEL AISI 304	•	•	•	•	•			Z7 22224
70/40		STAINLESS STEEL AISI 316L	•	•	•	•	•		1 internal flange, 1 external flange	4072100143
			•	•	•	•	•	BLUE		4072400363
		•	•	•	•	•	RED	4072400364		
	STAINLESS STEEL AISI 316L + COLOURED SILICONE RING	•	•	•	•	•	YELLOW	4072400365		
		•	•	•	•	•	WHITE	4072400366		
		•	•	•	•	•	GREEN	4072400367		
		STAINLESS STEEL AISI 304	•	•	•	•	•			4072100154

HOSE CONNECTORS AND REDUCTIONS – 3.B REDUCTION

REDUCTION	∅ mm	MATERIAL		COLOR	NOTES	CODE
	70/50	ZINC-PLATED	• • •			Z7 22001
		STAINLESS STEEL AISI 304	• • • •			Z7 22225
		STAINLESS STEEL AISI 316L	• • •			4072100144
		• • • •	BLUE	1 internal flange, 1 external flange	4072400368	
		• • • •	RED		4072400369	
		STAINLESS STEEL AISI 316L + COLOURED SILICONE RING	• • • •		YELLOW	4072400370
		• • • •	WHITE		4072400371	
		• • • •	GREEN		4072400372	
		STAINLESS STEEL AISI 304	• • • • •			4072100155
		100/50	ZINC-PLATED	• • •		
STAINLESS STEEL AISI 304	• • • •					Z7 22226
100/70	ZINC-PLATED	• • •			1 internal flange, 1 external flange	Z7 22125
	STAINLESS STEEL AISI 304	• • • •				Z7 22227
						4072100157









The reduction is a fitting that goes between a vacuum cleaner with a quick-fit inlet and a hose that has a smaller diameter than the inlet. The diameters of the components are different.

REDUCTION WITH FLOW
REGULATOR

Ø mm	MATERIAL												COLOR	NOTES	CODE
50/40	ZINC-PLATED			•										1 internal flange, 1 external flange	Z7 22112
	STAINLESS STEEL AISI 304	•		•		•	•			•					Z7 22234
70/40	ZINC-PLATED			•											4072400665
	STAINLESS STEEL AISI 304	•		•		•	•			•				1 internal flange, 1 external flange	Z7 22235
70/50	ZINC-PLATED			•											Z7 22162
	STAINLESS STEEL AISI 304	•		•		•	•			•					Z7 22236
100/50	ZINC-PLATED			•											4072400605
	STAINLESS STEEL AISI 304	•	•	•		•	•			•					Z7 22165
100/70	ZINC-PLATED			•											Z7 22163
	STAINLESS STEEL AISI 304	•	•	•		•	•			•					4072400719

The reduction with flow regulator is a special reduction which, as well as connecting the vacuum cleaner to a hose (with a smaller diameter than the inlet), lets you regulate the vacuum power by hand.

HOSE CONNECTORS AND REDUCTIONS – 3.B REDUCTION

BIFURCATION	Ø mm	MATERIAL	 	    	EXA	ACD	COLOR	NOTES	CODE
	40/40/40	ZINC-PLATED		.	.	.			Z7 22061
		STAINLESS STEEL AISI 304		Z7 22145
	50/50/50	ZINC-PLATED		.	.	.			Z7 22059
		STAINLESS STEEL AISI 304		Z7 22146
		STAINLESS STEEL AISI 316L		4072100147
		STAINLESS STEEL AISI 316L + COLOURED SILICONE RING	BLUE	1 internal flange
70/70/70	STAINLESS STEEL AISI 316L + COLOURED SILICONE RING	RED		4072400384
	STAINLESS STEEL AISI 316L + COLOURED SILICONE RING	YELLOW		4072400385
	STAINLESS STEEL AISI 316L + COLOURED SILICONE RING	WHITE		4072400386
	STAINLESS STEEL AISI 316L + COLOURED SILICONE RING	GREEN		4072400387
100/100/100	STAINLESS STEEL AISI 304			4072100158
	ZINC-PLATED		.	.	.			1 internal flange	Z7 22110
	STAINLESS STEEL AISI 304			Z7 22282
	ZINC-PLATED		.	.	.			1 internal flange	4072100159
100/100/100	STAINLESS STEEL AISI 304			Z7 22135
	STAINLESS STEEL AISI 304			Z7 22157
		STAINLESS STEEL AISI 304			4072100198

The bifurcation is a fitting used to connect the vacuum cleaner to two different hoses or, between hoses in general. Coloured versions have an internal flange with a coloured silicone ring.

BIFURCATION WITH REDUCTION



Ø mm	MATERIAL		COLOR	NOTES	CODE
40/32/32					Z7 22253
50/32/32	ZINC-PLATED			1 internal flange	Z7 22254
50/40/40	STAINLESS STEEL AISI 304	•			Z7 22261
	STAINLESS STEEL AISI 304	• •			4072100212
70/32/32	ZINC-PLATED				Z7 22252
70/40/40	STAINLESS STEEL AISI 304	•		1 internal flange	Z7 22262
	ZINC-PLATED				Z7 22064
70/50/50	STAINLESS STEEL AISI 304	•			Z7 22263
	STAINLESS STEEL AISI 304	• •			4072100205
	STAINLESS STEEL AISI 316L	•			4072200672
100/50/50	ZINC-PLATED				Z7 22128
	STAINLESS STEEL AISI 304	•		1 internal flange	4072200464
	ZINC-PLATED				Z7 22127
100/70/70	STAINLESS STEEL AISI 304	•			Z7 22307
	STAINLESS STEEL AISI 304	• •			4072100213

The bifurcation with reduction is a special bifurcation which, as well as letting you clean in two different places, connects the vacuum cleaner to two hoses of a smaller diameter than the inlet on the machine. Alternatively you can connect a hose to two others with smaller diameters than the first.

 BIFURCATION WITH FLOW
REGULATOR

Ø mm	MATERIAL		COLOR	NOTES	CODE
40/40/40	ZINC-PLATED				Z7 22114
50/50/50	STAINLESS STEEL AISI 304	•		1 internal flange	Z7 22056
	STAINLESS STEEL AISI 304	•			Z7 22250

The bifurcation with flow regulator is a special bifurcation which, a well as letting you clean in two different places, also lets you regulate the vacuum power of both tools.

HOSE CONNECTORS AND REDUCTIONS – 3.B REDUCTION

BIFURCATION WITH REDUCTION AND FLOW REGULATOR



Ø mm	MATERIAL		COLOR	NOTES	CODE
50/40/40	ZINC-PLATED	• • •			Z7 22057
70/50/50	STAINLESS STEEL AISI 304	• • • • •		1 internal flange	Z7 22065 Z7 22249
100/50/50	ZINC-PLATED	• • •			Z7 22130
100/70/70	ZINC-PLATED	• • •			Z7 22129

The bifurcation with reduction and flow regulator is a bifurcation with reduction for cleaning in two different places, and the vacuum power can be regulated manually for each tool.

TRIFURCATION



Ø mm	MATERIAL		COLOR	NOTES	CODE
50/50/50/50	ZINC-PLATED	• • •		1 internal flange	ZS07RW22027

The trifurcation is a fitting used to connect the vacuum cleaner to three different hoses or, between hoses in general. The trifurcation lets you clean in three different places using the same vacuum cleaner.







TRIFURCATION WITH FLOW REGULATOR



Ø mm	MATERIAL		COLOR	NOTES	CODE
50/50/50/50	ZINC-PLATED	• • •		1 internal flange	Z7 22179
70/40/40/40	STAINLESS STEEL AISI 304	• • • • •		1 internal flange and flow regulator	4072200719

The trifurcation with flow regulator is a special trifurcation which, a well as letting you clean in three different places, also lets you regulate the vacuum power of all three tools.

TRIFURCATION WITH
REDUCTION

Ø mm	MATERIAL	 	    	EXA	ACD	COLOR	NOTES	CODE
50/40/40/40	ZINC-PLATED			•	•	•		Z7 22260
	STAINLESS STEEL AISI 304	•	•	•	•	•		4072200654
70/50/50/50	ZINC-PLATED			•	•	•	1 internal flange	Z7 22259
	STAINLESS STEEL AISI 304	•	•	•	•	•		ZS07RE22019
100/50/50/50	ZINC-PLATED			•	•	•		ZS07IS22105
100/70/70/70	STAINLESS STEEL AISI 304	•	•	•	•	•		4072200723

The trifurcation with reduction is a special trifurcation which, as well as letting you clean in three different places, connects the vacuum cleaner to three hoses of a smaller diameter than the inlet on the machine. It can also be used to connect a hose to three other hoses of a smaller diameter.

3.c Examples: hose connectors and reductions



Ø 40 mm
Nilfisk
inlet

A



Ø 40 mm
Hose fitting
Z7 21005

C

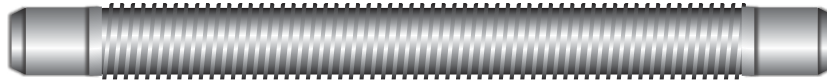

Ø 40 mm
3-meter Rubber Hose with sleeves
Z7 24005



Ø 70 mm
Nilfisk
inlet

A



Ø 70/50 mm
Reduction
Z7 22001

C

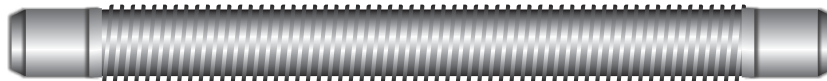

Ø 50 mm
3-meter conductive Flex Hose with sleeves
Z7 24053

A

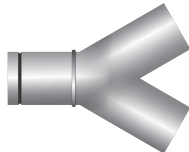

Ø 70/70/70 mm
Bifurcation
Z7 22110

C

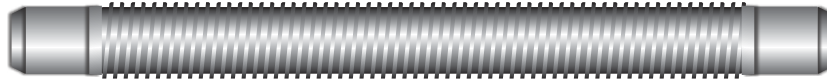

Ø 70 mm
3-meter Polyurethane Hose with sleeves
Z7 22367

C

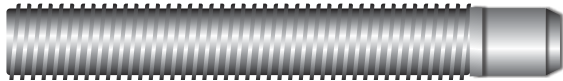

Ø 40 mm
3-meter Flex Hose with sleeves
Z7 22150

E

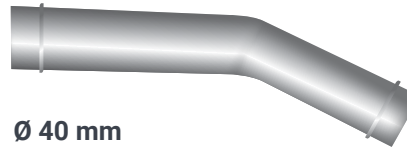

Ø 40 mm
Curved fitting
Z7 21013

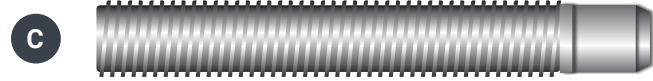

Ø 50 mm
3-meter Air Hose with sleeves
Z7 22062

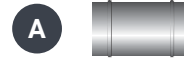

Ø 50 mm
Junction Fitting
Z7 21002

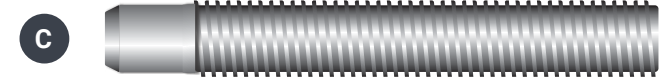

Ø 50 mm
3-meter Air Hose with sleeves
Z7 22062

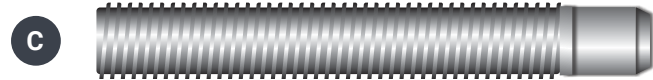

Ø 50 mm
3-meter Air Hose with sleeves
Z7 22062



Ø 50 mm
Hose fitting
Z7 21003



Ø 50 mm
Quick-fit fitting
Z7 22187

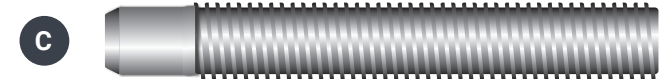

Ø 50 mm
3-meter Air Hose with sleeves
Z7 22062



Ø 50 mm
Old Nilfisk
inlet
Ø 38 mm
Old Nilfisk
inlet
Ø 50 mm
Old Nilfisk
inlet



Ø 50/40 mm
Complete bayonet coupling
adaptor **Z7 22381**
Ø 38/40 mm
Complete bayonet coupling
adaptor **Z7 22380**
Ø 50/50 mm
Complete bayonet coupling
adaptor **Z7 22382**



Ø 40 mm
3-meter conductive Polyurethane Hose with sleeves
Z7 22368
Ø 38 mm
3-meter conductive Flex Hose with sleeves
Z7 22374
Ø 50 mm
3-meter Rubber Hose with sleeves
Z7 24003

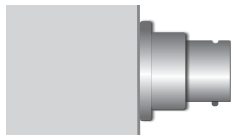

Ø 70 mm
EXA Machine
inlet

C



Ø 70/40 mm
Reduction
4072100154

B

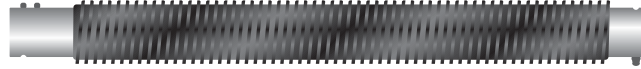

Ø 40 mm
3-meter Flex Antistatic Hose
4072400459

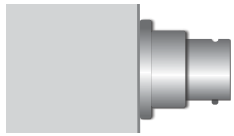

Ø 70 mm
EXA Machine
inlet

D

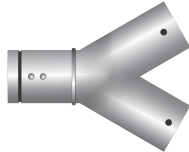

Ø 70/70/70 mm
Reduction
4072100159

B



Ø 70 mm
5-meter Transparent Antistatic Hose
4072400644

C



Ø 70/50 mm
Reduction
4072100155

B



Ø 50 mm
3-meter Flex Conductive Hose
4072400455

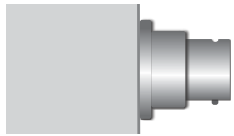

Ø 40 mm
EXA Machine
inlet

B



Ø 40 mm
3-meter flex conductive hose
4072400451

F



Ø 40 mm
Bent Fitting
4072100160

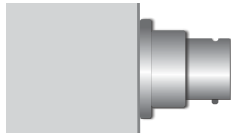

Ø 50 mm
EXA Machine
inlet

B



Ø 50 mm
3-meter Flex Conductive Hose
4072400455

B



Ø 50 mm
3-meter Flex Conductive Hose
4072400455

Handgrips and Extensions

The handgrips are essential for cleaning floors and should be used with the floor nozzle.

Fitted with a quick-fit coupling, the handgrips can be fitted to the floor nozzle quickly and simply.

The extensions are tubular elements for cleaning walls and other overhead areas in general.

Different kinds of extensions are available: dedicated extensions for cleaning ovens (with sliding PTFE sleeve) and those for cleaning pipes in raised areas.

In the last section you will find some of the possible connection schemes between handgrips and floor nozzles, and between extensions and different final tools/accessories.

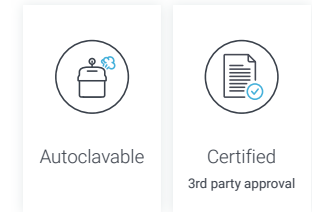

4.a Handgrips

HANDGRIP	Ø mm	Length mm	MATERIAL								EXA	ACD	COLOR	NOTES	CODE		
	40	1200	ZINC-PLATED			•			•	•					Z7 22121		
			ALUMINIUM			•			•	•						Z7 22026	
			STAINLESS STEEL AISI 304	•	•			•	•		•					40000215	
			STAINLESS STEEL AISI 316L + COLOURED SILICONE RING	•				•	•		•				BLUE	1 quick-fit fitting	4072200596
				•				•	•		•				RED		4072400398
				•				•	•		•				YELLOW		4072400399
				•				•	•		•				WHITE		4072400400
				•				•	•		•				GREEN		4072400401
				•				•	•		•						4072400402
			STAINLESS STEEL AISI 304	•	•	•				•	•	•					4072000385
			STAINLESS STEEL AISI 304 + COLOURED SILICONE RING	•	•	•				•	•	•			RED		4072200724
			50		ZINC-PLATED			•			•	•					
ALUMINIUM								•	•						Z7 22025		
STAINLESS STEEL AISI 304	•								•	•					40000222		
STAINLESS STEEL AISI 316L	•							•	•						4072200597		

HANDGRIP	Ø mm	Length mm	MATERIAL								EXA	ACD	COLOR	NOTES	CODE
	50	1200	STAINLESS STEEL AISI 316L + COLOURED SILICONE RING	•	•	•	•	•	•	•	•	•	BLUE	1 quick-fit fitting	4072400403
													RED		4072400404
													YELLOW		4072400405
													WHITE		4072400406
													GREEN		4072400407
		70	70	STAINLESS STEEL AISI 304	•	•	•	•	•	•	•	•	•		
ALUMINIUM	•	•		•	•	•	•	•	•	•	•		1 quick-fit fitting	Z7 22091	
			STAINLESS STEEL AISI 304	•	•	•	•	•	•	•	•	•			4072000442

The handgrip is essential for cleaning floors; it is the element which fits between the hose sleeve and floor nozzle. It has a quick-fit fitting and is available in various materials and diameters. Coloured versions have an internal flange with a coloured silicone ring.

EXTENSION WITH QUICK-FIT FITTING	Ø mm	Length mm	MATERIAL								EXA	ACD	COLOR	NOTES	CODE		
	40	1000		•	•	•	•	•	•	•	•	•			Z7 22008		
		2000													1 quick-fit fitting, 1 internal flange	Z7 22007	
		3000														Z7 22006	
	50	1000	ALUMINIUM	•	•	•	•	•	•	•	•	•	•			Z7 22270	
		2000														Double wanded version 1 quick-fit fitting, 1 internal flange	Z7 22267
		3000															Z7 22036
		1000														1 quick-fit fitting, 1 internal flange	Z7 22005
		2000															Z7 22004
		3000															Z7 22003
	70	1000	ALUMINIUM	•	•	•	•	•	•	•	•	•	•			Z7 22271	
		2000														Double wanded version 1 quick-fit fitting, 1 internal flange	Z7 22268
		3000															Z7 22037
		1000														1 quick-fit fitting, 1 internal flange	Z7 22274
		2000															Z7 22275

The aluminium extensions with quick-fit fittings are available in three different lengths, letting you attach final tools (make sure you remove the harmonic spring, if present) to clean high areas, pipes and walls. Thanks to the internal groove, these extensions can easily be connected together.









HANDGRIPS AND EXTENSIONS – 4.A HANDGRIPS

EXTENSION WITH QUICK-FIT COUPLING	Ø mm	Length mm	MATERIAL								EXA	ACD	COLOR	NOTES	CODE	
	40	1000	ALUMINIUM											1 quick-fit coupling with harmonic spring	Z7 22386	
			STAINLESS STEEL AISI 304	•	•	•	•	•	•							4072400658
	50	1000	ALUMINIUM												1 quick-fit coupling with harmonic spring	Z7 22385
			STAINLESS STEEL AISI 304	•	•	•	•	•	•							4072400659
	70		STAINLESS STEEL AISI 304	•	•	•	•	•	•						4072400717	
			STAINLESS STEEL AISI 304											Harmonic Springpin SPARE PART (for quick-fit coupling D40 and D50)	Z7 20328	
SLIDING SLEEVE																
	40		PTFE											Resistant to high temperatures. To use with quick-fit extensions with harmonic springs	Z7 20327	
	50														Z7 20326	

The aluminium extensions with quick-fit fittings and harmonic spring are 1 meter long, but can be easily extended as they are easy to fit together, with a hole on one end and a harmonic spring on the other. As well as their use for cleaning suspended parts (e.g. with coloured brushes together with the 50 mm coupling, code 4072200388, or the 50/40 mm coupling, code 4072200387), when combined with the PTFE sliding sleeve and the floor nozzle with silicone strip (cf. chap. 5.a) they are suitable for cleaning ovens (cf. chap 7, Oven Cleaning Kit).

EXTENSION HANDGRIP FOR IVT1000	Ø mm	Length mm	MATERIAL								EXA	ACD	COLOR	NOTES	CODE
	32	1000	STAINLESS STEEL AISI 316											The kit consists of two extensions made of AISI 316 steel	11112500
		250													Connecting tube

The 32 mm diameter stainless-steel extensions should only be used with the IVT1000 vacuum cleaner. The two available extensions can easily be connected together (conical type connection). The 250 mm long tube (32 mm diameter) is also only for the IVT1000. Made of stainless steel, it connects the hose to the final tool/accessory. Suitable for ACD applications when used with ACD machines connect ONLY with stainless steel 304 connector

FDA SILICONE RING	Ø mm	Length mm	MATERIAL								EXA	ACD	COLOR	NOTES	CODE				
	40		SILICONE										BLUE	SPARE PARTS: coloured silicone rings.	4082300073				
															RED	4082300074			
																YELLOW	4082300075		
																	WHITE	4082300076	
																	GREEN	4082300077	
	50			SILICONE											BLUE	4082300079			
																RED	4082300080		
																	YELLOW	4082300081	
																		WHITE	4082300082
																		GREEN	4082300083

4.b Examples: handgrips and extensions

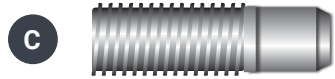

Ø 40 mm
3-meter conductive
Flex Hose with sleeves
Z7 22150

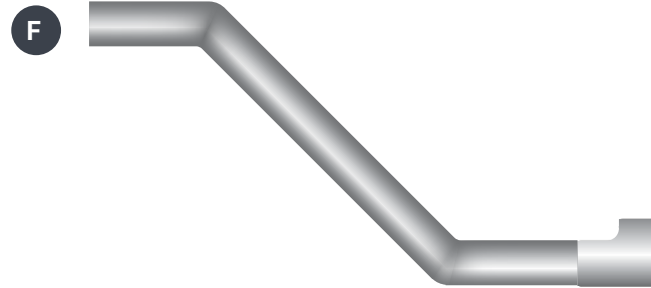

Ø 40 mm
Sleeve
Z7 22121



Ø 40 mm
Wheeled floor nozzle for dust
and liquids (400 mm)
Z7 22030

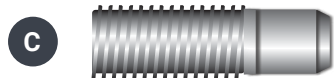

Ø 50 mm
3-meter Air Hose with
sleeves **Z7 22062**
Ø 40 mm
3-meter Air Hose with
sleeves **Z7 22049**



Ø 50 mm
Extensions with quick-fit fitting (3 meters) **Z7 22003**
Ø 40 mm
Extensions with quick-fit fitting (3 meters) **Z7 22006**



Ø 50 mm
Wall brush (400 mm)
Z7 22198

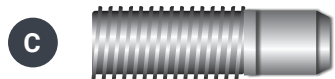

Ø 38 mm
3-meter conductive
Flex Hose with sleeves
Z7 22374



Ø 40 mm
Quick-fit extensions with harmonic spring
Z7 22386



Ø 40 mm
Wall brush (300 mm)
Z7 22194

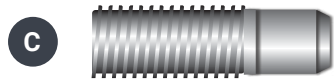

Ø 40 mm
3-meter Air Hose
with sleeves
Z7 22049



Ø 40 mm
Quick-fit extensions with harmonic spring
Z7 22386



Ø 50/40 mm
Extension fitting
with reduction
4072200387



Ø 50 mm
Curved brush for pipes (300 mm)
22432600

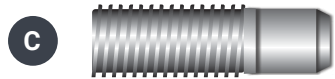

Ø 50 mm
3-meter Polyurethane
Hose with sleeves
Z7 22298



Ø 50 mm
Quick-fit extensions with harmonic spring
Z7 22385



Ø 50 mm
Extension fitting
with reduction
4072200388



Ø 50 mm
Brush for flat surfaces (300 mm)
22432905



B

Ø 40 mm
3-meter Flex
Conductive Hose
4072400451

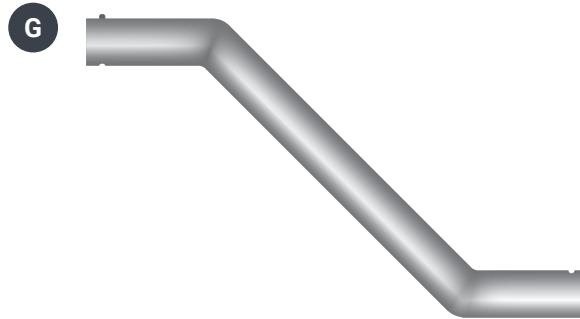

G

Ø 40 mm
EXA handgrip
4072000385



K

Ø 40 mm
Wheeled floor nozzle for dust
and liquids (400 mm)
4072000387



B

Ø 40 mm
3-meter Flex
Conductive Hose
4072400451



E

Ø 40 mm
EXA extension
4072400658



K

Ø 40 mm
Mobile coloured floor nozzle (400 mm)
4072400587

Floor nozzles and Brushes

The floor nozzles are used to clean solids and liquids from all types of surfaces. As well as the floor nozzles, brushes are also available to clean dust off floors and other surfaces such as walls and pipes.

The brushes only have bristles, while the floor nozzles have both rubber lips and bristle profiles.

Most Nilfisk floor nozzles and brushes come with certifications (e.g. FDA approval).

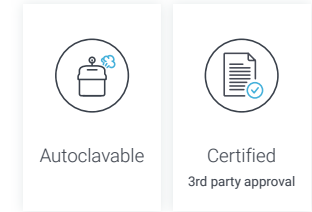

5.a Floor nozzles

MOBILE FLOOR NOZZLE FOR DUST AND LIQUIDS

	Ø mm	Length mm	MATERIAL										COLOR	NOTES	CODE	
	40	300	ZINC-PLATED											With two rubber lips (silicone for the stainless steel version), wheel adjuster screw and 1 internal flange	Z7 22171	
		400												Z7 22030		
	40	400	ZINC-PLATED + SILICONE LIPS											Anti-Shock Version With Silicone Lips	4072200651	
		400	STAINLESS STEEL AISI 304												40000216	
		400												4072000387		
		400												With two rubber lips (silicone for the stainless steel version), wheel adjuster screw and 1 internal flange	Z7 22172	
	50	40	ZINC-PLATED												Z7 22029	
		50	450	POLYPROPYLENE + ALUMINUM											PP body, aluminum frame with adjustable wheel height. Commercial floor nozzle with brushes to be ordered with the dedicated aluminum extension 4082500102	4072400664
			400	ZINC-PLATED + SILICONE LIPS											Anti-Shock Version With Silicone Lips	4072200650
400			STAINLESS STEEL AISI 304												40000223	
400															4072000388	
70	500	ZINC-PLATED												With two rubber lips (silicone for the stainless steel version), wheel adjuster screw and 1 internal flange	Z7 22147	
														Z7 22092		
	500	STAINLESS STEEL AISI 304													4072000452	
40	300/400	RUBBER (rubber lips 10 pieces)	FIXED WHEEL												Z8 20123	
																Z8 20295
	400/500	SILICONE													Z8 20255	

The wheeled floor nozzle, with rubber profile on the zinc-plated version and silicone profile on the stainless steel version, is ideal for cleaning dust and liquids. Thanks to the internal flange it is very easy to connect to the handgrips (cf. chapter 4.a). The new anti-shock versions have been implemented to be used in the B&C sector in order to dissipate any static charges caused by the passage of dust. The SS 304 nozzles are suitable for ACD applications when used with ACD machines connect ONLY with stainless steel 304 connector.

MOBILE COLOURED NOZZLES FOR DUST AND LIQUIDS	Ø mm	Length mm	MATERIAL										COLOR	NOTES	CODE
	40	400	STAINLESS STEEL AISI 316 + SILICONE FDA COVER	•	•	•	•	•	•	•	•	•	TRANSPARENT	Standard connection. Suitable for ACD applications when used with ACD machine connect ONLY with stainless steel 304 connector.	4072400314
													BLUE		4072400315
													RED		4072400316
													GREEN		4072400317
													YELLOW		4072400318
													WHITE		4072400319
													TRANSPARENT		4072400320
													BLUE		4072400321
													RED		4072400322
													GREEN		4072400323
	50	400	STAINLESS STEEL AISI 316 + SILICONE FDA COVER	•	•	•	•	•	•	•	•	•	TRANSPARENT	Dedicated connection for the EXA version	4072400324
													BLUE		4072400325
													RED		4072400587
													GREEN		4072400588
													YELLOW		4072400589
													WHITE		4072400590
													TRANSPARENT		4072400591
													BLUE		4072400592
													RED		4072400593
													GREEN		4072400594
	40	400	SILICONE COVER	•	•	•	•	•	•	•	•	•	TRANSPARENT	Spare parts valid for standard / ACD coloured nozzle and EXA version too	4072400595
													BLUE		4072400596
													RED		4072400597
													GREEN		4072400598
													YELLOW		4082300062
													WHITE		4082300063
													TRANSPARENT		4082300064
													BLUE		4082300065
													RED		4082300066
													GREEN		4082300067
YELLOW	4082300061														
	50	400	Silicone wheel	•	•	•	•	•	•	•	•	•	TRANSPARENT		4082300062
													BLUE		4082300063
													RED		4082300064
													GREEN		4082300065
													YELLOW		4082300066
													WHITE		4082300067
													TRANSPARENT		4082300061
													BLUE		
													RED		
													GREEN		
YELLOW															
WHITE															

The coloured floor nozzle can be used to apply the colour coded program in the food & pharma sectors.

FLOOR NOZZLES AND BRUSHES – 5.A FLOOR NOZZLES

COLOURED NOZZLE



Ø mm	Length mm	MATERIAL										COLOR	NOTES	CODE
40	400	STAINLESS STEEL AISI 316 + NBR FDA COVER										BLUE		4072400304
												RED		4072400305
												GREEN		4072400306
												YELLOW		4072400307
												WHITE		4072400308
												BLUE		4072400309
												RED		4072400310
												GREEN		4072400311
50	400	STAINLESS STEEL AISI 316 + NBR FDA COVER										YELLOW		4072400312
												WHITE		4072400313
												SILICONE		Spare part: silicone lip Z8 20255

Stainless steel nozzle with coloured cover to be used in the food sector to apply the colour coded program.

WHEELED FLOOR NOZZLE FOR DUST



Ø mm	Length mm	MATERIAL										COLOR	NOTES	CODE	
40	300	ZINC-PLATED												Z7 22174	
	400													Z7 22138	
	300													With two brush lips, wheel adjuster screw and 1 internal flange	Z7 22175
	400													Z7 22137	
	500													Z7 22148	
	70											500			Z7 22149
300/400	500	BRUSH STRIPS											Spare part: brush strips (10 pieces)	Z8 23040	
	500												Z8 23041		

The wheeled floor nozzle with bristle profile is ideal for cleaning dust. Thanks to the internal flange it is very easy to connect to the handgrips (cf. chapter 4.a).

NOZZLE FOR OVENS	Ø mm	Length mm	MATERIAL		COLOR	NOTES	CODE
	40	400	ZINC-PLATED			With two silicone lips, wheel adjuster screw, 1 internal flange and harmonic spring quick-fit coupling	Z7 22272
	50						Z7 22273
	40	400	ALUMINIUM			1 internal flange and 1 quick-fit coupling with harmonic spring	Z7 22031
	50						Z7 22032
	40	500	STAINLESS STEEL AISI 316 BASE WITH HEAT RESISTANT COVER			1 internal flange	4072400326
	50						4072400327
		500	SILICONE			Spare part: Silicone lip	Z8 20255

The nozzles for cleaning ovens are special components resistant to high temperatures. There are two versions available: the first has wheels and silicone lips, the second is made completely of aluminium. Both have quick-fit couplings with harmonic spring so they can easily be connected to the extensions, which also have harmonic spring quick-fit couplings, as shown in chapter 4.b.

NOZZLE FOR BUSES	Ø mm	Length mm	MATERIAL		COLOR	NOTES	CODE
	50	200	ALUMINIUM			"C" bristle profile and 1 internal flange	Z7 22170

The nozzle for buses, thanks to its compact dimensions and "C" bristle profile is ideal for cleaning the corridors of buses. Made entirely of aluminium, it has an internal flange for the quick-fit coupling with the relevant handgrip (cf. chapter 4.a).

FLOOR NOZZLES AND BRUSHES – 5.A FLOOR NOZZLES

FLOOR NOZZLE FOR LIQUIDS



Ø mm	Length mm	MATERIAL										COLOR	NOTES	CODE
40	400	ZINC-PLATED												Z7 22028
		STAINLESS STEEL												Z7 22296
50	500	ZINC-PLATED											With two lips made of rubber (silicone for the stainless steel version), two Nylon shoes and 1 internal flange	Z7 22168
	400	STAINLESS STEEL												Z7 22027
	500	ZINC-PLATED											Z7 22294	
	300/400	RUBBER											Spare part: rubber lips 10 pieces	Z8 20295
	500													Z8 20296

The floor nozzles for liquids are suitable for cleaning liquids off floors. They have two rubber lips, or silicone lips on the stainless steel versions. They are easy to connect to the handgrips thanks to the internal groove on the fitting of the floor nozzle.

FIXED FLOOR NOZZLE



Ø mm	Length mm	MATERIAL										COLOR	NOTES	CODE
50	500												For D400 Platform, also LP versions	4072200695
													For D400 EXA machines	4072200758
70	600	ZINC-PLATED											With two lips made of rubber and two wheels	Z7 22085
													For S2/S3 model	4056000487
	700												For CTS model	4056000393
													With two lips made of rubber and two wheels	Z7 22086
		RUBBER										With a bristle profile	Z7 22248	
												Spare part: rubber lip 600-700 mm	Z8 20297	

The fixed floor nozzle is a special floor nozzle ideal for cleaning dust on large surface areas. The fixed floor nozzle has two rubber lips and two wheels. It is very easy to connect it to the vacuum cleaner thanks to the 70 mm diameter quick-fit fitting.

FLOOR NOZZLE FOR IVT1000













Ø mm	Length mm	MATERIAL										COLOR	NOTES	CODE
			.											22431611
32	300	STAINLESS STEEL AISI 304 + POLYPROPYLENE	.										Bristle profile and stainless steel coupling	22431608
			.										Silicone profile, FDA approved and stainless steel coupling	22430808

These three floor nozzles are designed specifically for the IVT1000 vacuum cleaner. As well as the standard version and the antistatic version there is also a model with a silicone profile, approved by the FDA and suitable for autoclaves.

All three floor nozzles are suitable for cleaning dust and for ACD applications when used with ACD machines connect ONLY with stainless steel 304 connector

5.b Brushes

BRUSH	Ø mm	Length mm	MATERIAL	        	COLOR	NOTES	CODE
	40	220	PVC BRUSH + METAL CONNECTION	.	.	FLOOR BRUSH: bristle profile, 90° brush elbow fitting and 1 internal flange	Z7 22042
		300		.	.		Z7 22043
		400		.	.		Z7 22044
	50	220		.	.		Z7 22038
		300		.	.		Z7 22039
		400		.	.		Z7 22040
		500		.	.		Z7 22041
	70	300		.	.		Z7 22077
		400		.	.		Z7 22078
		500		.	.		Z7 22093
	40	220	PVC BRUSH + METAL CONNECTION	.	.	WALL BRUSH: bristle profile, 30° brush elbow fitting and 1 internal flange and quick-fit coupling with harmonic spring	Z7 22193
		300		.	.		Z7 22194
		400		.	.		Z7 22195
	50	220		.	.		Z7 22196
		300		.	.		Z7 22197
		400		.	.		Z7 22198
		500		.	.		Z7 22199
	70	220		.	.		Z8 23009
		300		.	.		Z8 23010
		400		.	.		Z8 23011
	500	.	.	Z8 23012			

The rectangular-section 90° brushes are ideal for removing and cleaning dust from floors, while the 30° brushes are ideal for cleaning walls. Both types, with a PVC structure, have a black bristle profile. The 90° brushes connect to the handgrips described in chapter 4.a, while the wall brushes connect to the extensions described in chapter 4.b (in particular, when used with the quick-fit extensions, remember to always remove the harmonic spring from the brushes).

CURVED BRUSH FOR PIPES



Ø mm	Length mm	MATERIAL		COLOR	NOTES	CODE
40	100	PVC BRUSH				Z7 22132
	200					Z7 22134
50	100					Z7 22131
	200					Z7 22133
100	100					Z8 24042
	200					Z8 24043

The curved brush is designed for cleaning pipes, especially in suspended installations. Its rounded shape makes it particularly effective for removing and cleaning dust. This element must be used with the extensions described in chapter 4.b (in particular, when used with the quick-fit extensions, remember to always remove the harmonic spring from the brushes).

NOZZLE FOR FLAT SURFACES



Ø mm	Length mm	MATERIAL		COLOR	NOTES	CODE
50	300	POLYPROPYLENE		GREEN	NOZZLE FOR FLAT SURFACES: with rubber lip, FDA approved	22432306
	300			BLACK		22432302
	300			GREEN	NOZZLE SPARE PART: the floor nozzle fitting is not included	32430806
	300			BLACK		32430802
		ZINC-PLATED			NOZZLE FITTING SPARE PART: swivel fitting	10645031
		STAINLESS STEEL AISI 304				10645011

The coloured nozzles for flat surfaces with rubber lip are specific nozzles for environments where foodstuffs and pharmaceuticals are processed (in particular for cleaning high areas). Available in the autoclave and conductive versions, all FDA approved, these nozzles come in three colours: green, grey and black (conductive version). Thanks to the swivel fitting (to connect to quick-fit extensions with harmonic spring using the 50/40 mm reduction, code 4072200387, or with a 50 mm extension fitting, code 4072200388), the manoeuvrability and functionality are unbeatable.

FLOOR NOZZLES AND BRUSHES – 5.B BRUSHES

BRUSH FOR FLAT SURFACES



Ø mm	Length mm	MATERIAL		COLOR	NOTES	CODE
50	300	POLYPROPYLENE		BLACK	BRUSH FOR FLAT SURFACES: bristle profile, FDA approved, black	22432902
				BLUE	BRUSH FOR FLAT SURFACES: bristle profile, suitable for autoclaves, FDA approved, blue	22432907
				BLACK	BRUSH SPARE PARTS: the floor nozzle fitting is not included	42431602
		BLUE		42431607		
		YELLOW		42431604		
					ZINC-PLATED	
		STAINLESS STEEL AISI 304				10645011

The coloured brushes for flat surfaces, with a bristle profile, are also designed for cleaning environments where foodstuffs and pharmaceuticals are processed, especially for cleaning high areas. These brushes, available in various colours, are suitable for autoclaves and are FDA approved. With a swivel fitting, these brushes must be used with quick-fit extensions with harmonic spring and the relevant fittings (with 50/40 mm reduction and harmonic spring or 50 mm fitting with harmonic spring).

CURVED BRUSH FOR PIPES



Ø mm	Length mm	MATERIAL		COLOR	NOTES	CODE		
50	100	POLYPROPYLENE		BLACK	CURVED BRUSH FOR PIPES: bristle profile, FDA approved	22432402		
	200					22432502		
	300					22432602		
	100						42430902	
	200						CURVED BRUSH SPARE PARTS: the brush fitting is not included	42431002
	300							42431102
		ZINC-PLATED			BRUSH FITTING SPARE PARTS: swivel fitting	10645031		
		STAINLESS STEEL AISI 304				10645011		

The curved, coloured brushes for pipes, with a bristle profile, are ideal for cleaning dust off pipes in suspended installations. Available in two colours, grey and black (conductive version), and in three sizes, they are FDA approved. With a swivel fitting, these brushes must be used with quick-fit extensions with harmonic spring and the relevant fittings (with 50/40 mm reduction and harmonic spring or 50 mm fitting with harmonic spring).

5.c Examples: Floor nozzles and Brushes

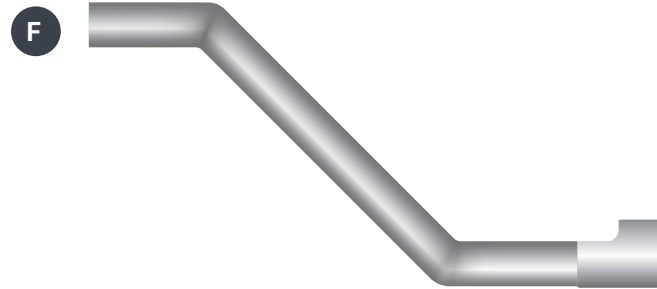

Ø 40 mm
Handgrip
Z7 22121



Ø 40 mm
Floor nozzle for liquids (400 mm) **Z7 22296**
Ø 40 mm
Wheeled floor nozzle for dust (500 mm) **Z7 22138**

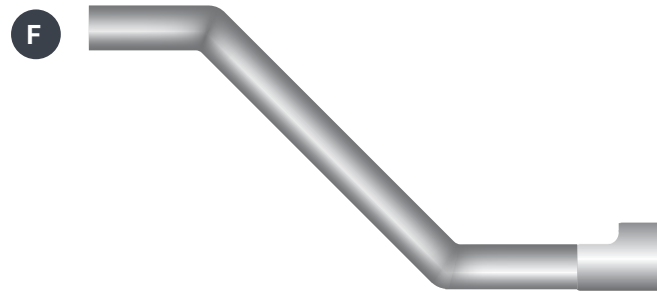

Ø 50 mm
Handgrip
40000222



Ø 50 mm
Floor brush (300 mm)
Z7 22039



Ø 40 mm

Quick-fit extensions with harmonic spring

Z7 22386

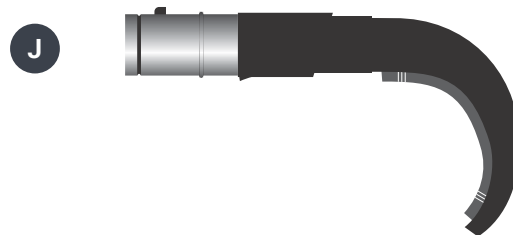

Ø 40 mm

Curved brush for pipes (200 mm)

Z7 22134



Ø 40 mm

Quick-fit extensions with harmonic spring

7 22386



Ø 40/50 mm

Extension fitting
with reduction

4072200387



Ø 50 mm

Nozzle for flat surfaces (300 mm)

22432302



Ø 50 mm

Quick-fit extensions with harmonic spring

7 22385

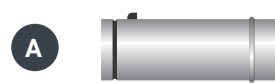

Ø 50 mm

Extension fitting

4072200388



Ø 50 mm

Nozzle for flat surfaces (300 mm)

22432302

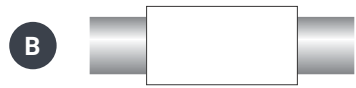

B

Ø 40 mm
Sliding PTFE sleeve
7 20327



D

Ø 40 mm
Quick-fit extensions with harmonic spring
7 22386



K

Ø 40 mm
Wheeled nozzle for ovens (400 mm)
7 22272



K

Ø 40 mm
Nozzle for ovens (400 mm)
7 22031

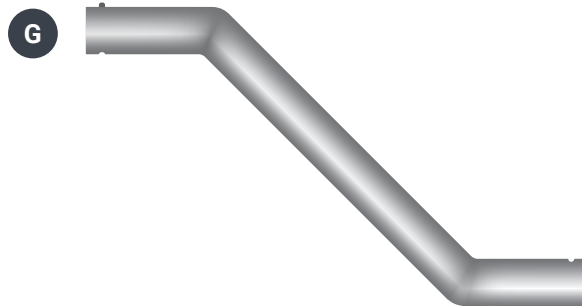

G

Ø 40 mm
EXA handgrip
4072000385



K

Ø 40 mm
Mobile coloured floor nozzle (400 mm)
4072400587







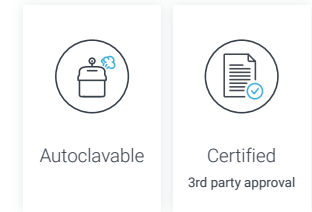





Final tools

All the final tools/accessories such as rubber and antistatic rubber cones, natural- and Nylon-bristle round brushes, zinc-plated and stainless-steel flat-tip crevice nozzles are grouped together in the category "Final tools".

Successful cleaning also depends on these elements.



6.a Rubber tools

CONE	∅ mm	MATERIAL	 	      	COLOR	NOTES	CODE
	40	NBR		• • •	RED		Z7 21011
		CONDUCTIVE NBR		• • • •	BLACK		40000214
		STAINLESS STEEL AISI 304 + CONDUCTIVE NBR	•	• • • •	BLACK	Oilproof	4072400505
	40	SILICONE		• •	TRANSPARENT		4072100105
				• • •	BLUE		4072100106
				• • • •	RED	When use with ACD machine connect ONLY with stainless steel 304 connector	4072100107
				• • • •	GREEN		4072100108
				• • • •	YELLOW		4072100109
				• • • •	WHITE		4072100110
	40	STAINLESS STEEL AISI 304 + SILICONE		• • • •	TRANSPARENT		4072400507
				• • • •	BLUE		4072400508
			• •	• • • •	RED		4072400509
			• •	• • • •	GREEN		4072400510
			• •	• • • •	YELLOW		4072400511
	• • • •	WHITE		4072400512			

CONE	∅ mm	MATERIAL		COLOR	NOTES	CODE				
	50	NBR		RED		Z7 21010				
				GREY	Length 245 mm, GREY	80650900				
		GREY		Length 500 mm, GREY	80691100					
		CONDUCTIVE NBR		Oilproof	40000221					
		STAINLESS STEEL AISI 304 + CONDUCTIVE NBR		Oilproof	4072400506					
		TRANSPARENT			4072100111					
		BLUE			4072100112					
		RED		When use with ACD machines connect ONLY with stainless steel AISI 304 connector	4072100113					
		GREEN			4072100114					
		YELLOW			4072100115					
WHITE	4072100116									
	50	SILICONE		TRANSPARENT		4072400513				
				BLUE		4072400514				
				RED		4072400515				
				GREEN		4072400516				
				YELLOW		4072400517				
				WHITE		4072400518				
					50	STAINLESS STEEL AISI 304 + SILICONE		TRANSPARENT		4072400513
								BLUE		4072400514
								RED		4072400515
								GREEN		4072400516
YELLOW		4072400517								
WHITE		4072400518								
70	70	NBR						RED		Z7 21009
		CONDUCTIVE NBR						BLACK		4072100194
		STAINLESS STEEL AISI 304 + CONDUCTIVE NBR		BLACK	Oilproof	4072400718				

The black nitrile rubber cones are the conductive model, while the red ones are standard. They are oil-resistant and therefore suitable for cleaning shavings and liquids from machine tools. The length varies from 200 mm to a maximum of 500 mm. The silicone version, available only with a 40 mm diameter, is suitable for autoclaves. These cones can be connected both to junction fittings and curved fittings.

Coloured silicone versions are FDA approved and suitable for the food sector. They are all provided with metal connectors with the pushbutton already mounted.

This metal connection will keep the same diameter of the terminal tool.

Coloured tools have been tested to be used in zone 22 ATEX classified areas, so it means they can collect dust. The use of these accessories in zone 22 ATEX environment is allowed only if they are connected to an antistatic or dissipative flex hose by means of stainless steel metal parts, all provided by Nilfisk.

FINAL TOOLS – 6.A RUBBER TOOLS

CONICAL TOOL D32



∅ mm	MATERIAL		COLOR	NOTES	CODE
32	NBR	• •	GREY		81141101
	CONDUCTIVE NBR	• • •	BLACK	When use with ACD machine connect ONLY with stainless steel 304 connector	81932600
	CONDUCTIVE NBR	• • •	BLACK	With bristles on the top of the tool, when use with ACD machine connect ONLY with stainless steel 304 connector	4072100167
	SILICONE	• • • •	TRANSPARENT WHITE	Silicone conical tool + FDA approved round brush ring with longer blue bristles FDA	81141103
40	STAINLESS STEEL + CONDUCTIVE NBR	• • • •	TRANSPARENT WHITE	Length: 195mm long, Straight shape	4072100186
			BLACK	With reduction 40/32	4072400520
	CONDUCTIVE NBR	• • • •	BLACK	With reduction 40/32 and with bristles on the top of the tool	4072400599

The 240 mm final cone is for use on the IVT1000 vacuum cleaner. Three versions are available: standard, anti-static and autoclave-safe (in silicone). They must always be used with the connecting tube (code 11882505) The certified and marked version is available both with bristles and without.

50/20 CONICAL TOOL



∅ mm	MATERIAL		COLOR	NOTES	CODE
40	ZINC-PLATED + CONDUCTIVE NBR Z8 24046	• • • •		Supplied with 50/40 mm zin-plated reduction + Curved tip	Z7 22142
50	ZINC-PLATED + CONDUCTIVE NBR Z8 24046	• • • •		Supplied with 50 mm zin-plated junction fitting + Curved tip	Z7 22141
	STAINLESS STEEL + CONDUCTIVE NBR Z8 24046	• • • •	BLACK	Supplied with 50 mm stainless steel junction fitting + Curved tip	4072400416
	CONDUCTIVE NBR	• • • •		CURVED TIP (the fitting and the reduction are not included)	Z8 24046
	NBR	• • • •		Optional spare part: straight shape (the fitting and the reduction are not included)	82167400

The 50/20 final cones are 300 mm long and are generally used to clean dust and thread-like residue.



SILICONE CONICAL TOOL













∅ mm	MATERIAL		COLOR	NOTES	CODE	
40	FDA SILICONE	.	TRANSPARENT	With junction fitting D40 inserted inside the silicone conical tool or junction fitting D50 inserted outside the silicone conical tool	4072100129	
			BLUE		4072100130	
			RED		4072100131	
			GREEN		When use with ACD machines connect ONLY with stainless steel AISI 304 connector	4072100132
			YELLOW		4072100133	
			WHITE		4072100134	
	STAINLESS STEEL AISI304 + FDA SILICONE	. Only dust, II 2D	TRANSPARENT	Available only in D40	4072400534	
			BLUE		4072400535	
			RED		4072400536	
			GREEN		4072400537	
			YELLOW		4072400538	
			WHITE		4072400539	
FDA SILICONE	.	YELLOW	Only the straight shape without the curved fitting	4072100215		
		RED	4072100189			











The silicone conical tool is available only in D40 internal and D50 external. This shape can be modified by cutting the tip of the nozzle thanks to predefined internal flanges. These final tools can be connected both to junction fittings and curved fittings.

FINAL TOOLS – 6.A RUBBER TOOLS











RUBBER NOZZLE	∅ mm	MATERIAL								EXA	ACD	COLOR	NOTES	CODE		
	40	SILICONE	•									TRANSPARENT		4072100117		
			•										BLUE		4072100118	
			•											RED	When use with ACD machine connect ONLY with stainless steel 304 connector	4072100119
			•											GREEN		4072100120
			•											YELLOW		4072100121
			•											WHITE		4072100122
		•											TRANSPARENT			4072400522
		•											BLUE			4072400523
		STAINLESS STEEL AISI 304 + SILICONE	•											RED		4072400524
			•	Only dust, II 2D										GREEN		4072400525
			•											YELLOW		4072400526
			•											WHITE		4072400527
•												GREY	120 mm	Z7 21030		
•												BLACK		Z7 21080		
	50	NBR	•									TRANSPARENT		4072100123		
			•										BLUE		4072100124	
		SILICONE	•											RED	When use with ACD machine connect ONLY with stainless steel 304 connector	4072100125
			•											GREEN		4072100126
			•											YELLOW		4072100127
			•											WHITE		4072100128
		STAINLESS STEEL AISI 304 + CONDUCTIVE NBR	•											BLACK	120 mm	4072400519
			•											BLACK	200 mm	4072400521
		STAINLESS STEEL AISI 304 + SILICONE	•											TRANSPARENT		4072400528
			•	Only dust, II 2D										BLUE		4072400529

RUBBER NOZZLE	∅ mm	MATERIAL	 	      	COLOR	NOTES	CODE
	50	STAINLESS STEEL AISI 304 + SILICONE	Only dust, II 2D	• • •	RED		4072400530
					GREEN		4072400531
					YELLOW		4072400532
					WHITE		4072400533
					GREY	200 mm	80640500
					BLACK	200 mm, when use with ACD machine connect ONLY with stainless steel 304 connector	80640501
	PVC	200 mm	82167300				

The rubber floor nozzle is ideal for removing shavings and dust, thanks to its toothed profile; it is available in a grey standard version and a black conductive version. The floor nozzle must be used with a 50/40 mm reduction or a 50 mm junction fitting. Alternatively, it can be used with a curved fitting and a 50/40 mm reduction or a 50 mm curved fitting. The PVC oilproof nozzle (25 mm x 90 mm) is a special nozzle in this group.

CREVICE NOZZLES	∅ mm	MATERIAL	 	      	COLOR	NOTES	CODE
 	32	STAINLESS STEEL AISI 304	•	• •		For IVT1000, 250 mm long	80552000
		ZINC-PLATED		• • •		1 external flange	Z7 21027
		PVC		• • •	GREY	500 mm	Z7 22022
	40	STAINLESS STEEL AISI 304	•	• • •		1 external flange	40000213
		STAINLESS STEEL AISI 316L	•	• •			4072100148
			•	• •	BLUE		4072400388
			•	• •	RED		4072400389
		STAINLESS STEEL AISI 316L + SILICONE	•	• •	GREEN	1 external flange and silicone ring	4072400390
			•	• •	YELLOW		4072400391
			•	• •	WHITE		4072400392

FINAL TOOLS – 6.A RUBBER TOOLS

CREVICE NOZZLES	Ø mm	MATERIAL	 	    	EXA	ACD	COLOR	NOTES	CODE	
	40	PVC		•			BLACK	500 mm	Z7 24014	
		STAINLESS STEEL AISI 304	•			•			4072100162	
		STAINLESS STEEL AISI 304 + COLOURED SILICONE RING	•				•	RED		4072200726
	50/40	ZINC-PLATED		•				1 external flange	Z7 22021	
			•					1 external flange	Z7 21026	
		ZINC-PLATED	•						1 internal flange	Z7 21074
			•						1 external flange, curved version	Z7 21075
	50	PVC		•			BLACK	500 mm	Z7 24013	
		STAINLESS STEEL AISI 304		•					1 external flange, when use with ACD machine connect ONLY with stainless steel 304 connector	40000220
		STAINLESS STEEL AISI 316L	•		•					4072100149
			•		•			BLUE		4072400393
			•		•			RED		4072400394
		STAINLESS STEEL AISI 316 L + COLOURED SILICONE RING	•		•			GREEN	Internal flange and silicone ring, when use with ACD machine connect ONLY with stainless steel 304 connector	4072400395
			•		•			YELLOW		4072400396
	•		•			WHITE		4072400397		
		STAINLESS STEEL AISI 304	•						4072100163	
	70	ZINC-PLATED		•				1 external flange	Z7 21028	
		PVC		•			BLACK	1000 mm, curved version	Z7 24012	
		STAINLESS STEEL AISI 304	•							4072100193

The crevice nozzles, made of metal and PVC are ideal for cleaning shavings, dust and liquids. In particular, the flat-tip crevice nozzles are the best tool for cleaning in corners, while the ones with perimeter brush effectively remove and clean dust. Metal flat-tip crevice nozzles are also available for special requirements, curved and with reductions. Coloured versions are available with an internal flange with a silicone coloured ring for the food sector.

CREVICE NOZZLES WITH BRUSH	∅ mm	MATERIAL		COLOR	NOTES	CODE
	40	ZINC-PLATED			Steel perimeter brush	Z7 22024
					Nylon perimeter brush	Z7 22088
	50				Steel perimeter brush	Z7 22023
					Nylon perimeter brush	Z7 22089

Three crevice nozzle with brush is ideal for cleaning sticky material that must be removed from the surface. Both steel and nylon brushes are available.

CREVICE NOZZLES WITH HANDLES	∅ mm	MATERIAL		COLOR	NOTES	CODE
	70	ALUMINIUM				Z7 22169
	100					Z7 22190

Aluminium crevice nozzles with handles are recommended For more heavy-duty use.

FLUIDIFYING NOZZLE	∅ mm	MATERIAL		COLOR	NOTES	CODE
	40	ZINC-PLATED				Z7 22053
						Z7 22054
	50	ALUMINIUM			ZA7210024	
		ZINC-PLATED			Z7 22055	
	70				ZA7210026	
		ALUMINIUM			ZA7210019	

The fluidifying tools are normally used when you have to clean a notable quantity of material, both scattered dust and heaps of dust. Thanks to the particular construction, with a double concentric tube, the fluidifying tool, with or without regulator, is very efficient during the suction phase.

FINAL TOOLS – 6.A RUBBER TOOLS

SCRAPER NOZZLES



Ø mm	MATERIAL	 	    	EXA	ACD	COLOR	NOTES	CODE
40	ZINC-PLATED		•	•	•		Length 1000 mm – Width 110 mm	Z7 22033
	STAINLESS STEEL AISI 304	•	•	•	•	•	Length 1000 mm – Width 110 mm, when use with ACD machine connect ONLY with stainless steel 304 connector	Z7 22277 4072100179
50	ZINC-PLATED		•	•	•		Length 1000 mm – Width 150 mm	Z7 22034
	STAINLESS STEEL AISI 304	•	•	•	•	•	Length 1000 mm – Width 150 mm, when use with ACD machine connect ONLY with stainless steel 304 connector	Z7 22278 4072100180
70	ZINC-PLATED		•	•	•		Length 1000 mm – Width 200 mm	Z7 22090





The scraper nozzles, available in various widths and one length (1000 mm), are ideal for scraping and vacuuming floors. Also EXA version is available.

ROUND BRUSHES



Ø mm	MATERIAL	 	    	EXA	ACD	COLOR	NOTES	CODE
40	ZINC-PLATED		•	•	•		Round brush with nylon bristles, 1 internal flange and 1 quick-fit coupling with harmonic spring	Z7 22045
		•	•	•	•		Round brush with steel bristles, 1 internal flange and 1 quick-fit coupling with harmonic spring	Z7 22046
50	ZINC-PLATED		•	•	•		Round brush with nylon bristles, 1 internal flange and 1 quick-fit coupling with harmonic spring	Z7 22047
		•	•	•	•		Round brush with steel bristles, 1 internal flange and 1 quick-fit coupling with harmonic spring	Z7 22048
	NYLON BRISTLES						Round brush spare part with nylon bristles, for round brush with D40	Z8 23005
	NYLON BRISTLES						Round brush spare part with nylon bristles, for round brush with D50	Z8 23006
	STEEL BRISTLES						Round brush spare part with steel bristles, for round brushes with D40 and D50	Z8 23008

Round brushes are generally used to clean dust. They can be connected directly to a hose using the relevant sleeve or can be connected to the extensions shown in chapter 4.b (in particular if used with quick-fit extensions, remember to always remove the harmonic spring from the fitting of the round brushes).

CONDUCTIVE ROUND BRUSHES	Ø mm	MATERIAL		COLOR	NOTES	CODE
	40	CONDUCTIVE PVC + NYLON + BRASS	•	BLACK	With black nylon bristles and brass bristles	4072400262
			•	BLACK	With Stainless Steel EXA connector	4072400540
	50	CONDUCTIVE PVC + NYLON + BRASS	•	BLACK	With black nylon bristles and brass bristles	4072400263
			•	BLACK	With Stainless Steel EXA connector	4072400541
		NYLON + BRASS	• •	BLACK	SPARE PART: with nylon and brass bristles for the conductive version of the brush	4072400270

Conductive round brushes are suitable for ATEX and ACD machines and applications. These final tools can be connected both to junction fittings and curved fittings.

FINAL TOOLS – 6.A RUBBER TOOLS

COLOURED ROUND BRUSHES	Ø mm	MATERIAL								EXA	ACD	COLOR	NOTES	CODE		
	38	ALUMINIUM			•								With polypropylene bristles, wood body with an aluminium fitting, 100 mm diameter round brush	10989000		
	50	NBR			•								With natural bristles	12422500		
													Spare part: ONLY curved fitting	80625000		
	40	PVC + POLYPROPYLENE											BLACK	With black bristles made of polypropylene	4072200576	
													RED	With red bristles made of polypropylene	4072200577	
														GREEN	With green bristles made of polypropylene	4072200578
														BLUE	With blue bristles made of polypropylene	4072200579
														WHITE	With white bristles made of polypropylene	4072200580
														YELLOW	With yellow bristles made of polypropylene	4072200581
	50	POLYPROPYLENE											BLACK	With black bristles made of polypropylene	4072200570	
												RED	With red bristles made of polypropylene	4072200571		
													GREEN	With green bristles made of polypropylene	4072200572	
													BLUE	With blue bristles made of polypropylene	4072200573	
													WHITE	With white bristles made of polypropylene	4072200574	
													YELLOW	With yellow bristles made of polypropylene	4072200575	
	50	POLYPROPYLENE										BLACK		4072400264		
													RED		4072400265	
														GREEN		4072400266
														BLUE	Bristles spare parts	4072400267
														WHITE		4072400268
														YELLOW		4072400269
	40	FDA NBR + NYLON			•	•	•	•	•			BLUE		4072400274		
					•	•	•	•	•				RED		4072400275	
					•	•	•	•	•	•				GREEN	FDA approved material, when use with ACD machine connect ONLY with stainless steel 304 connector	4072400276
					•	•	•	•	•	•				YELLOW		4072400277
					•	•	•	•	•	•				WHITE		4072400278
40	FDA NBR + NYLON											BLUE-BLUE	FDA approved material-blue connection and blue bristles	4072400606		
													RED-RED	FDA approved material-red connection and red bristles	4072400607	
													GREEN-GREEN	FDA approved material-green connection and green bristles	4072400608	
													YELLOW-YELLOW	FDA approved material-yellow connection and yellow bristles	4072400609	

COLOURED ROUND BRUSHES

	∅ mm	MATERIAL								EXA	ACD	COLOR	NOTES	CODE	
	40	STAINLESS STEEL AISI 304 + FDA NBR + NYLON	BLUE	With Stainless Steel EXA connector	4072400542	
												RED		4072400543	
												GREEN		4072400544	
												YELLOW		4072400545	
												WHITE		4072400546	
												YELLOW-YELLOW		FDA approved material-yellow connection and yellow bristles	4072400662
												RED-RED		FDA approved material-red connection and red bristles	4072400713
												GREEN-GREEN		FDA approved material-green connection and green bristles	4072400714
												BLUE-BLUE		FDA approved material-blue connection and blue bristles	4072400715
												BLUE		FDA approved material	4072400279
RED	4072400280														
GREEN	4072400281														
YELLOW	4072400282														
WHITE	4072400283														
YELLOW-YELLOW	FDA approved material-yellow connection and yellow bristles	4072400728													
RED-RED	FDA approved material-red connection and red bristles	4072400729													
GREEN-GREEN	FDA approved material-green connection and green bristles	4072400730													
BLUE-BLUE	FDA approved material-blue connection and blue bristles	4072400731													
	50	STAINLESS STEEL AISI 304 + FDA NBR + NYLON	BLUE	With Stainless Steel EXA connector		4072400547
												RED		4072400548	
												GREEN		4072400549	
												YELLOW		4072400550	
												WHITE		4072400551	
												YELLOW-YELLOW		FDA approved material-yellow connection and yellow bristles	4072400732
												RED-RED		FDA approved material-red connection and red bristles	4072400733
												GREEN-GREEN		FDA approved material-green connection and green bristles	4072400734
												BLUE-BLUE		FDA approved material-blue connection and blue bristles	4072400735
												WHITE		Spare part: coloured bristles, suitable for all FDA round brushes	4082300058
GREEN	4082300114														
YELLOW	4082300128														
BLUE	4082300129														
RED	4082300144														

These round brushes, all with a rubber structure (except for one model in wood and aluminium), are always used for removing and cleaning dust.

The round brushes with 38 mm coupling should be used together with the fitting with 40/38 mm reduction (code 4072200390, see chap 3.b), while the brushes with 50 mm coupling can be connected directly to the curved fittings shown in chapter 3.a. These two types of round brushes can also easily be connected to quick-fit extensions with harmonic spring (see chapter 4.b): via the fitting with 40/38 mm reduction (code 4072200389) and via the 50 mm coupling (code 4072200388), for round brushes with 38 mm and 50 mm couplings, respectively.

Suitable for ACD applications when used with ACD machine connect ONLY with stainless steel 304 connector.

FINAL TOOLS – 6.A RUBBER TOOLS

COLOURED TRIANGULAR BRUSHES



Ø mm	MATERIAL								EXA	ACD	COLOR	NOTES	CODE	
40	FDA NBR + NYLON	BLUE	FDA approved material	4072400284	
		RED		4072400285	
		GREEN		4072400286	
		YELLOW		4072400287	
		WHITE		4072400288	
	RED-RED	FDA approved material-red connection and red bristles	4072400602	
	STAINLESS STEEL AISI 304 + FDA NBR + NYLON	BLUE	With Stainless Steel EXA connector	4072400552
		RED		4072400553
		GREEN		4072400554
		YELLOW		4072400555
.		WHITE	4072400556		
50	FDA NBR + NYLON	BLUE	FDA approved material	4072400289	
		RED		4072400290	
		GREEN		4072400291	
		YELLOW		4072400292	
		WHITE		4072400293	
	STAINLESS STEEL AISI 304 + FDA NBR + NYLON	BLUE	With Stainless Steel EXA connector	4072400557
		RED		4072400558
		GREEN		4072400559
		YELLOW		4072400560
		WHITE		4072400561
NYLON BRISTLES	WHITE	Spare part: coloured bristles suitable for all FDA triangular brushes	4082300059	
	GREEN		4082300115	

FDA triangular brushes are suitable for the Food sector to apply the colour coded program. These final tools can be connected both to junction fittings and curved fittings. Suitable for ACD applications when used with ACD machine connect ONLY with stainless steel 304 connector.

COLOURED RECTANGULAR BRUSHES



Ø mm	MATERIAL								EXA	ACD	COLOR	NOTES	CODE
40	FDA NBR + NYLON	•	•	•	•	•	•	•	•	•	BLUE	FDA approved material	4072400294
											RED		4072400295
											GREEN		4072400296
											YELLOW		4072400297
											WHITE		4072400298
40	STAINLESS STEEL AISI 304 + FDA NBR + NYLON	•	•	•	•	•	•	•	•	•	BLUE	With Stainless Steel EXA connector	4072400562
											RED		4072400563
											GREEN		4072400564
											YELLOW		4072400565
											WHITE		4072400566
50	FDA NBR + NYLON	•	•	•	•	•	•	•	•	•	BLUE	FDA approved material	4072400299
											RED		4072400300
											GREEN		4072400301
											YELLOW		4072400302
											WHITE		4072400303
50	STAINLESS STEEL AISI 304 + FDA NBR + NYLON	•	•	•	•	•	•	•	•	•	BLUE	With Stainless Steel EXA connector	4072400567
											RED		4072400568
											GREEN		4072400569
											YELLOW		4072400570
											WHITE		4072400571
	NYLON BRISTLES	•	•	•	•	•	•	•	•	•	WHITE	Spare part: bristles suitable for all FDA rectangular brushes	4082300060

FDA rectangular brushes are suitable for the Food sector to apply the colour coded program. These final tools can be connected both to junction fittings and curved fittings. Suitable for ACD applications when used with ACD machine connect ONLY with stainless steel 304 connector.

6.b Examples: final tools

E

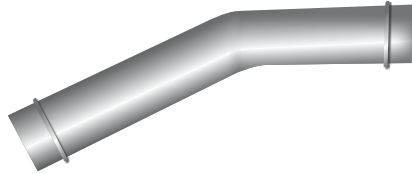

Ø 50 mm
Curved fitting
Z7 21034

I



Ø 50 mm
Cone
Z7 21010

K



Ø 50 mm
Rubber nozzle
Z7 21080

C

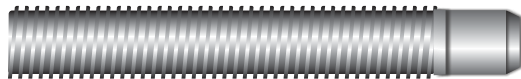

Ø 40 mm
3-meter Air Hose with sleeves
Z7 22049

I

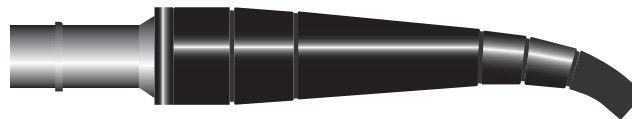

Ø 40 mm
Conical tool
Z7 22142

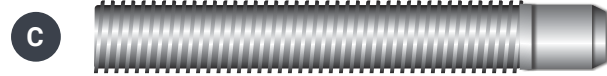

Ø 50 mm
3-meter Polyurethane Hose with sleeves
Z7 22298



Ø 50 mm
Junction Fitting
Z7 21002



Ø 50 mm
Rubber nozzle
4072100124

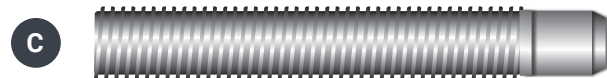

Ø 40 mm
3-meter conductive Flex Hose with sleeves
Z7 22150



Ø 40 mm
Scraper nozzle
Z7 22033

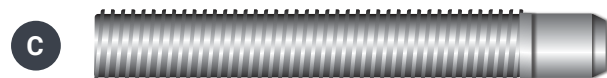

Ø 50 mm
3-meter conductive Flex Hose with sleeves
Z7 22375



Ø 50 mm
Curved flat-tip crevice nozzle
Z7 21075

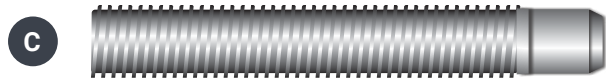

Ø 70 mm
3-meter Polyurethane Hose with sleeves
Z7 22299

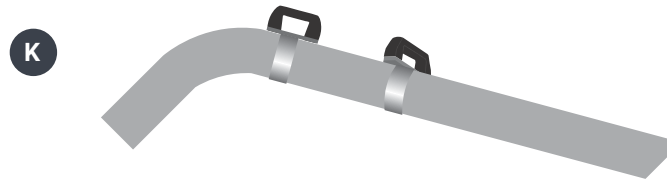

Ø 70 mm
Round crevice nozzle with handles
Z7 22169

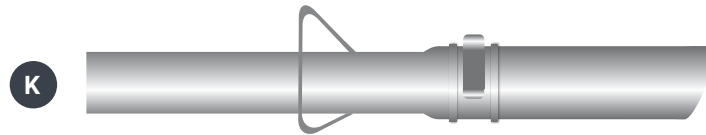

Ø 70 mm
Fluidifying vulk nozzle with regulator
ZA7210026



Ø 40 mm
Quick-fit extensions with harmonic spring
Z7 22386



Ø 40/38 mm
Extension fitting
with reduction
4072200389

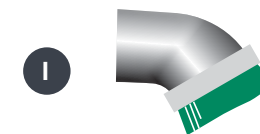

Ø 38 mm
Round brush
10950202



D

Ø 40 mm
Quick-fit extensions with harmonic spring
Z7 22386



J

Ø 40 mm
Round brush
Z7 22045

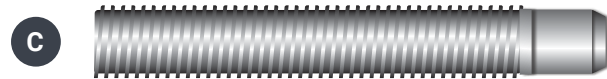

C

Ø 50 mm
Air Hose by meter
Z7 22062



H

Ø 50 mm
Round brush
Z7 22047

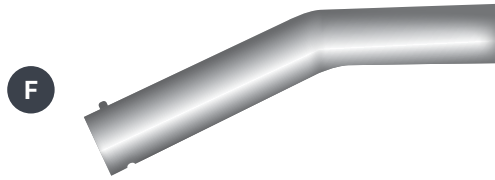

F

Ø 40 mm
EXA bent fitting
4072100160



K

Ø 40 mm
Silicone cone D40 blue ATEX complete
4072400508

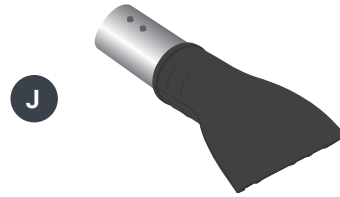

J

Ø 50 mm
Conductive nozzle D50 120 mm ATEX complete – suction point 120 mm
4072400519

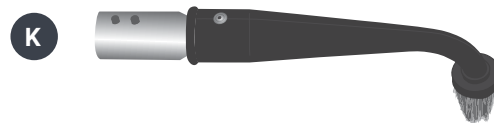

K

Ø 32 mm
Conductive nozzle D32 240 mm length ATEX complete + Stainless Steel reduction D40/32
4072400599



J

Ø 40 mm
Silicone conical tool FDA red D40/20 ATEX complete
4072400544

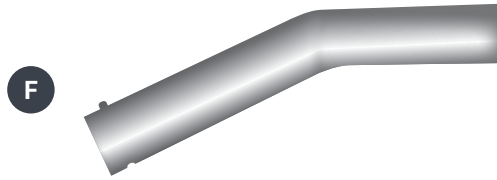

F

Ø 40 mm
EXA bent fitting
4072100160



I

Ø 40 mm
Round brush FDA green D40 ATEX complete
4072400544



E

Ø 40 mm
EXA extension
4072400658

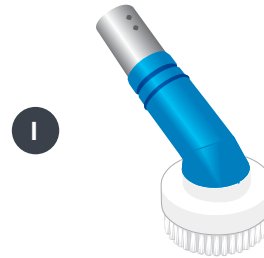

I

Ø 40 mm
Round brush FDA blue D40 ATEX complete
4072400542



B

Ø 40 mm
3-meter Flex Conductive Hose
4072400451

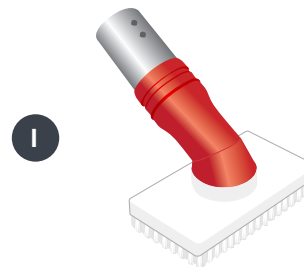

I

Ø 40 mm
Rectangular brush D40 ATEX complete red
4072400542

Accessories Kit

A wide range of kits is available: from sets of accessories for general cleaning, to kits for special applications (ex. cleanrooms), to groups of accessories for typical industrial applications and series of accessories for cleaning machinery in general.



















 Oilproof	 Conductive (*)	 Antistatic (**)
 High Temperature	 Autoclavable	 Certified 3rd party approval

GENERAL CLEANING KIT	Ø mm	Length meters	Composition	     	      	Code
	40	3	<ul style="list-style-type: none"> • Zinc-plated reduction Ø 50/40 • 3 m Flex hose with sleeves • Chromed handgrip • Wheeled floor nozzle for dust and liquids (width 400 mm) • Rubber cone • Round brush with Nylon bristles (80 mm) • Zinc-plated flat-tip crevice nozzle (length 500 mm) • Zinc-plated junction fitting 			Z7 24145
	50	3	<ul style="list-style-type: none"> • Zinc-plated reduction Ø 70/50 • 3 m Flex hose with sleeves • Chromed handgrip • Wheeled floor nozzle for dust and liquids (width 500 mm) • Rubber cone • Round brush with Nylon bristles (100 mm) • Zinc-plated flat-tip crevice nozzle (length 500 mm) • Zinc-plated junction fitting 			Z7 24146

The accessories kit for general cleaning is a set of components suitable for light applications. Thanks to the numerous elements (handgrip, wheeled floor nozzle, cone, flat-tip crevice nozzle, etc.) it is extremely versatile. It is available in two sizes: 40 mm and 50 mm diameter.

(*) **Conductive** A conductive hose / sleeve is a hose / sleeve with a volume resistance < 10⁴ ohm. It may have a conductor built in.
 (**) **Antistatic** An antistatic hose is a hose with a volume resistance < 10⁹ ohm and/or with a conductor built in.

INDUSTRIAL CLEANING KIT













	Ø mm	Length meters	Composition														Code	
	40	3	<ul style="list-style-type: none"> • Zinc-plated reduction Ø 50/40 • 3 m Polyurethane hose with sleeves • Chromed handgrip • Wheeled floor nozzle for dust and liquids (width 400 mm) • Rubber cone • Round brush with Nylon bristles (80 mm) • Zinc-plated flat-tip crevice nozzle (length 500 mm) • Zinc-plated junction fitting 															Z7 24150
	50	3	<ul style="list-style-type: none"> • Zinc-plated reduction Ø 70/50 • 3 m Polyurethane hose with sleeves • Chromed handgrip • Wheeled floor nozzle for dust and liquids (width 500 mm) • Rubber cone • Round brush with Nylon bristles (100 mm) • Zinc-plated flat-tip crevice nozzle (length 500 mm) • Zinc-plated junction fitting 															Z7 24151
	70	5	<ul style="list-style-type: none"> • Zinc-plated reduction Ø 100/70 • 5 m Polyurethane hose with sleeves • Chromed handgrip • Wheeled floor nozzle for dust and liquids D70 (width 500 mm) • Zinc-plated junction fitting • Rubber cone 															4072400247

The industrial cleaning accessories kit is ideal for cleaning spacious areas. Consisting of a 3 meter polyurethane hose, and a complete set of single accessories, this kit lets you clean areas quickly and effectively. The kit in D70 includes the hose in 5 m length. The hose must be connected properly if needed.

ACCESSORIES KIT

CLEANING MACHINERY KIT















Ø mm	Length meters	Composition	            	Code
40	3	<ul style="list-style-type: none"> • Zinc-plated reduction Ø 50/40 • 3 m Polyurethane hose with sleeves • Zinc-plated junction fitting • Conical tool • Rubber cone 	• • • •	Z7 24155
50	3	<ul style="list-style-type: none"> • Zinc-plated reduction Ø 70/50 • 3 m Polyurethane hose with sleeves • Zinc-plated junction fitting • Conical tool • Rubber cone • Rubber sucker 	• • • •	Z7 24156
70	5	<ul style="list-style-type: none"> • Zinc-plated reduction Ø 100/70 • 5 m Polyurethane hose with sleeves • Zinc-plated junction fitting • Conical tool • Zinc-plated flat lance 	• • • •	4072400248

The kit for cleaning machinery is a set of accessories specifically designed for cleaning dust and residues in general from machinery used during the phases of production and/or other processes. Thanks to the specific components, such as the rubber cone, cleaning is particularly effective. Also in this case there are three available sizes: 40 mm, 50 mm e 70 mm diameter. The hose must be connected properly if needed.









FLOORS AND MACHINERY OILPROOF KIT



Ø mm	Length meters	Composition	            	Code
40	3	<ul style="list-style-type: none"> • Zinc-plated reduction Ø 50/40 • 3 m rubber hose with sleeves • Zinc-plated junction fitting • Rubber cone • Chromed handgrip • Wheeled floor nozzle for dust and liquids (width 400 mm) 	• • • •	4072400194
50	3	<ul style="list-style-type: none"> • Zinc-plated reduction Ø 70/50 • 3 m rubber hose with sleeves • Zinc-plated junction fitting • Rubber cone • Chromed handgrip • Wheeled floor nozzle for dust and liquids (width 500 mm) 	• • • •	4072400195
70	5	<ul style="list-style-type: none"> • Zinc-plated reduction Ø 100/70 • 5 m rubber hose with sleeves • Zinc-plated junction fitting • Rubber cone • Chromed handgrip • Wheeled floor nozzle for dust and liquids (width 500 mm) 	• • • •	4072400249

The oilproof accessories KITS, for both floors and machinery, are suitable for treating all surfaces where oils have to be sucked up. Consisting of oil-resistant rubber accessories, these kits are available in two sizes: 40 mm, 50 mm and 70 mm diameter.

PHARMA ACCESSORIES KIT

	Ø mm	Length meters	Composition														Code	
	40	3	<ul style="list-style-type: none"> • AISI 316L reduction Ø 50/40 • 3 m antistatic hose with sleeves • AISI 316L bent connection • AISI 316L flat lance • AISI 316L handgrip • Mobile nozzle + silicone • Silicone cone 															4072200612
	50	3	<ul style="list-style-type: none"> • AISI 316L connection tube Ø 50 • 3 m antistatic hose with sleeves • AISI 316L bent connection • AISI 316L flat lance • AISI 316L handgrip • Mobile nozzle + silicone • Silicone cone 															4072200613
	40	3	<ul style="list-style-type: none"> • AISI 316L reduction Ø 50/40 • 3 m silicone hose with sleeves • AISI 316L bent connection • AISI 316L flat lance • AISI 316L handgrip • Mobile nozzle + silicone • Silicone cone 															4072200614
	50	3	<ul style="list-style-type: none"> • AISI 316L connection tube Ø 50 • 3 m silicone hose with sleeves • AISI 316L bent connection • AISI 316L flat lance • AISI 316L handgrip • Mobile nozzle + silicone • Silicone cone 															4072200615

Two different kits have been developed according to the main needs in the pharmaceutical production companies.
The difference is the type of hose: the standard kit includes the antistatic transparent hose, while the premium kit includes the new silicone hose.

ACCESSORIES KIT

IVT1000 KIT

Ø
mm Length
meters

Composition



Code



32

3

- 3 m plastic hose with sleeves
- Stainless steel extension/handgrip (2 pieces)
- Standard nozzle (width 300 mm)
- Stainless steel connecting tube (length 250 mm)
- Rubber cone
- Stainless steel flat-tip crevice nozzle (length 250 mm)
- Metal hose clamp (2 pieces)

• • •

80551100

- 3 m antistatic plastic hose with sleeves
- Stainless steel extension/handgrip (2 pieces)
- Antistatic nozzle (width 300 mm)
- Stainless steel connecting tube (length 250 mm)
- Conductive conical tool
- Stainless steel flat-tip crevice nozzle (length 250 mm)
- Metal hose clamp (2 pieces)

•

• • •

80551200

- 3 m silicone hose with sleeves
- Stainless steel extension/handgrip (2 pieces)
- Nozzle for autoclaves (width 300 mm)
- Stainless steel connecting tube (length 250 mm)
- Silicone cone
- Stainless steel flat-tip crevice nozzle (length 250 mm)
- Metal hose clamp (2 pieces)

•

• • •

80556700

These three accessories kits are only for the IVT1000 vacuum cleaner. All three are only available with a 32 mm diameter. While the standard set is indicated for light applications, the antistatic kit is ideal where antistatic applications are required; the autoclave kit is an optimal solution for all applications where the accessories have to be sterilized. The metal accessories are made of AISI316 stainless steel.

ALIMENTARY KIT FLOOR

	Ø mm	Length meters	Composition	     	      	Code
	40	3	<ul style="list-style-type: none"> Stainless steel reduction Ø 50/40 3 m rubber hose for food Stainless steel handgrip Stainless steel wheeled floor nozzle for dust and liquids (width 400 mm) 	•	• •	4072400210
	50	3	<ul style="list-style-type: none"> Stainless steel hose fitting Ø 50 3 m rubber hose for food Stainless steel handgrip Stainless steel wheeled floor nozzle for dust and liquids (width 400 mm) 	•	• •	4072400209
	40	3	<ul style="list-style-type: none"> Stainless steel reduction Ø 50/40 3 m rubber hose for food Stainless steel junction fitting Flat lance Silicone cone 	•	• •	4072400206
	50	3	<ul style="list-style-type: none"> Stainless steel reduction Ø 50/40 3 m rubber hose for food Stainless steel junction fitting Flat lance Silicone cone Silicone nozzle 	•	• •	4072400205

The alimentary kit includes an FDA hose and there are two versions for floor cleaning and machinery cleaning.















ACCESSORIES KIT

OVENS KIT	Ø mm	Length meters	Composition	     	      	Code
	40	3	<ul style="list-style-type: none"> • 3 m flexible steel hose with zinc-plated reduction D50/40 and fitting • Aluminium 1 m extension D40 (3 pieces) with quick-fit coupling • Wheeled nozzle for cleaning ovens • Sliding PTFE sleeve D40 	•	•	Z7 24193
	40	3	<ul style="list-style-type: none"> • 3 m flexible steel hose with zinc-plated reduction D70/40 and fitting D40 • Aluminium 2 m extension D40 (1 pieces) with quick-fit coupling • Aluminium 1 m extension D40 (1 pieces) with quick-fit coupling • Wheeled nozzle for cleaning ovens • Sliding PTFE sleeve D40 	•	•	4072400254
	50	3	<ul style="list-style-type: none"> • 3 m flexible steel hose with zinc-plated reduction D70/50 and fitting • Aluminium 1 m extension D50 (3 pieces) with quick-fit coupling • Wheeled nozzle for cleaning ovens • Sliding PTFE sleeve D50 	•	•	Z7 24192
	40	3	<ul style="list-style-type: none"> • High temperature flexible hose D40 (3 meters + metal ties) with zinc-plated reduction D50/40 and fitting • Aluminum 1 m extension D40 (3 pieces) with quick-fit coupling • Wheeled nozzle for oven cleaning • Sliding PTFE sleeve D40 	•	•	4072200616
	50	3	<ul style="list-style-type: none"> • High temperature flexible hose D50 (3 meters + metal ties) with zinc-plated reduction D70/50 and fitting • Aluminum 1 m extension D50 (3 pieces) with quick-fit coupling • Wheeled nozzle for cleaning ovens • Sliding PTFE sleeve D50 	•	•	4072200617















The oven cleaning kit is a specific set of accessories designed for cleaning inside ovens. Consisting of a 3 meter steel hose, with sleeve (silicone) and all the fittings and reductions necessary, three 1 m extensions with a sliding PTFE sleeve and a wheeled nozzle with two silicone lips, this set is very practical and effective, also thanks to the connecting system (with harmonic spring) and the reduced weight. There are two sizes available: 40 mm and 50 mm diameter.

The kit with the flexible hose includes the hose made up with glass fiber and silicone reinforced tissue with galvanized steel spiral and its metal ties.















ATEX KIT

	Ø mm	Length meters	Composition	            	Code
	40	3	<ul style="list-style-type: none"> • 3 m Flex conductive Hose • Conductive sleeve (2 pieces D38) • Stainless steel handgrip • Stainless steel wheeled floor nozzle for dust and liquids (width 400 mm) • Stainless steel curved fitting • Conductive cone • Stainless steel flat-tip crevice nozzle 	•	Z7 24185
	38/40	3	<ul style="list-style-type: none"> • 3 m Flex conductive Hose • Conductive sleeve (2 pieces D38/40) • Stainless steel handgrip • Stainless steel wheeled floor nozzle for dust and liquids (width 400 mm) • Stainless steel curved fitting • Conductive cone • Stainless steel flat-tip crevice nozzle 	•	4072400246
	50	3	<ul style="list-style-type: none"> • 3 m Flex conductive Hose • Conductive sleeve (2 pieces) • Stainless steel handgrip • Stainless steel wheeled floor nozzle for dust and liquids (width 400 mm) • Stainless steel curved fitting • Conductive cone • Stainless steel flat-tip crevice nozzle 	•	Z7 24182
	40	3	<ul style="list-style-type: none"> • 3 m Flex conductive Hose • Conductive sleeve (2 pieces D38) • Stainless steel handgrip • Stainless steel wheeled floor nozzle for dust and liquids (width 400 mm) 	•	Z7 24186
	50	3	<ul style="list-style-type: none"> • 3 m Flex conductive Hose • Conductive sleeve (2 pieces) • Stainless steel handgrip • Stainless steel wheeled floor nozzle for dust and liquids (width 400 mm) 	•	Z7 24183

ACCESSORIES KIT

ATEX KIT	Ø mm	Length meters	Composition	            	Code									
	40	3	<ul style="list-style-type: none"> • 3 m Flex conductive Hose • Conductive sleeve (2 pieces D38) • Stainless steel curved fitting • Conductive cone • Stainless steel flat-tip crevice nozzle 	•	•	•	•	•	•	•	•	•	•	Z7 24187
	50	3	<ul style="list-style-type: none"> • 3 m Flex conductive Hose • Conductive sleeve (2 pieces) • Stainless steel curved fitting • Conductive cone • Stainless steel flat-tip crevice nozzle 	•	•	•	•	•	•	•	•	•	•	Z7 24184
	40	3	<ul style="list-style-type: none"> • 3 m Flex conductive Hose • Conductive sleeve (2 pieces D38) • Conductive cone • Stainless steel flat-tip crevice nozzle 	•	•	•	•	•	•	•	•	•	•	Z7 24175

The ATEX accessories kits, including the kit for the 15ATEX vacuum cleaner, are an optimal solution when conductivity is obligatory. Available in three versions, from the complete version for cleaning both floors and machinery, to the version for cleaning machinery, or the set for cleaning floors, these accessories kits consist of conductive or antistatic elements. Each kit is available in two different sizes: 40 mm and 50 mm diameter.

ANTISHOCK KIT	Ø mm	Length meters	Composition	            	Code									
	40	5	<ul style="list-style-type: none"> • Chromed reduction (the reduction 50/40 for the kit D40, and the reduction 70/50 for the kit D50) • 5 m flex conductive hose • 2 conductive sleeves • Chromed handgrip 	•	•	•	•	•	•	•	•	•	•	4072200653
	50		<ul style="list-style-type: none"> • Wheeled anti-shock floor nozzle for dust (width 400 mm) with silicone lips • Zinc plated curved fitting • Antistatic round brush • Zinc plated flat lance • Conductive cone 	•	•	•	•	•	•	•	•	•	•	4072200652

The new anti-shock version has been implemented to be used in the B&C sector in order to dissipate any static charges caused by the passage of dust. It includes a conductive hose, a conductive cone, an antistatic round brush and a specific anti-shok nozzle with silicone lips.

ACD KIT

Ø
mm Length
meters

Composition



Code



40

- ACD Food Accessories Kit:**
- Antistatic FDA Hose 5m + Sleeves,
 - SS Handgrip,
 - SS Curved Connection,
 - FDA Mobile Nozzle + Silicone FDA Cover,
 - Silicone FDA Cone,
 - SS Reduction 50/40

4072400766



40

- ACD General Cleaning Kit:**
- Flex Antistatic Hose 5m + Sleeves,
 - SS Handgrip,
 - SS Curved Connection,
 - Anti-Shock Mobile Nozzle,
 - Antistatic Cone,
 - Antistatic Round Brush,
 - SS Flat Lance,
 - SS Reduction 50/40

4072400768

















50

- ACD General Cleaning Kit:**
- Flex Antistatic Hose 5m + Sleeves,
 - SS Handgrip,
 - SS Curved Connection,
 - Anti-Shock Mobile Nozzle,
 - Antistatic Cone,
 - Antistatic Round Brush,
 - SS Flat Lance,
 - SS Reduction 50/40,
 - SS Hose Connector D40 (use the reduction or the hose connector according to the diameter of the machine)

4072400769

The ACD accessories kits include: antistatic hose, antistatic or conductive terminal tools, and in case of silicone tools, the connection must be done with a SS component. They are both for cleaning the floor and the machineries.

ACCESSORIES KIT

EXA KIT	Ø mm	Length meters	Composition	            	Code									
	40	5	<ul style="list-style-type: none"> • ATEX Accessories Kit (complete) • Conductive Hose 5 m, • Handgrip, • Curved Connection, • Mobile Sucker, • Conductive Cone, • Flat Lance, • Antistatic Round Brush 	•	•	•	•	•	•	•	•	•	•	4072200662
	50		•	•	•	•	•	•	•	•	•	•	•	4072200663
	40	5	<ul style="list-style-type: none"> • ATEX Antistatic Accessories Kit (complete) • Antistatic Hose 5 m, • Handgrip, • Curved Connection, • Mobile Sucker, • Conductive Cone, • Flat Lance, • Antistatic Round Brush 	•	•	•	•	•	•	•	•	•	•	4072200666
	50		•	•	•	•	•	•	•	•	•	•	•	4072200667
	40	5	<ul style="list-style-type: none"> • Antistatic Accessories Kit for floor cleaning • Antistatic Hose 5 m, • Handgrip, • Mobile Sucker 	•	•	•	•	•	•	•	•	•	•	4072200668
	50		•	•	•	•	•	•	•	•	•	•	•	4072200669
	40	5	<ul style="list-style-type: none"> • Antistatic Accessories Kit for machines cleaning • Antistatic Hose 5 m, • Curved Connection, • Conductive Cone, • Flat Lance, • Antistatic Round Brush 	•	•	•	•	•	•	•	•	•	•	4072200670
	50		•	•	•	•	•	•	•	•	•	•	•	4072200671

The EXA accessories kit includes certified accessories suitable for EXA machines. It is available in 2 versions for cleaning both floors and machinery. All items include the PIN connection.

OVERHEAD CLEANING KIT

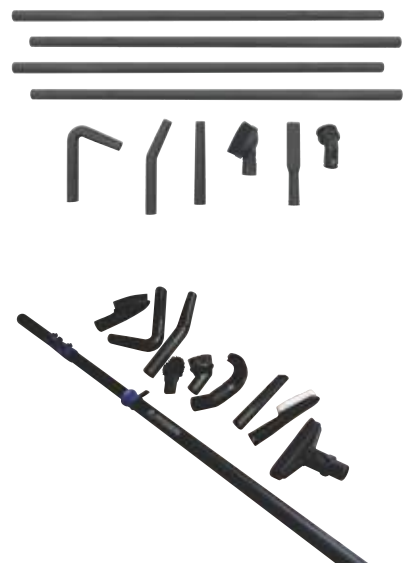

∅
mm

Composition



Code

40

- Adapter for the hose
- 4 Carbon fiber poles (6 meters)
- 2 Round brushes of different diameters
- Conductive flat lance
- 2 Curved connectors

.

.

.

.

.

.

4072400651

40

- 1 telescopic pole (7m)
- Silicone sleeve (to be mounted on the hose)
- 2 curved connectors
- 1 curved brush for pipes
- 1 flat lance
- 5 different brushes (for specific usages)

.

.

4072400765

- Camera for the overhead cleaning kit

4072300127

The new carbon fiber kit is suitable for overhead cleaning. It doesn't include the hose, so it can be connected to standard hoses with sleeves. It can be used with EXA machines thanks to the connection hoses. (see chapter 2.a Hoses- connection EXA hoses).

CONVERSION KIT



∅
mm

Composition



Code

50

.

.

.

.

4089100928

70

- Conversion kit for grey line machines

.

.

.

.

4089100929

100

.

.

.

.

4089100930

50

- Conversion kit for grey line machines – New version in 1 unique piece – more compact solution

.

.

.

.

4089101020

70

.

.

.

.

4089101004

50

- Conversion kit for VHW series

.

.

.

.

4089100981

70

.

.

.

.

4089100982

The conversion kit has been developed to allow the usage of EXA certified accessories also on machines already on the field. They are available for both the Grey line and also the White line.

Notes

A series of horizontal dotted lines for writing notes.

Notes

A series of horizontal dotted lines for writing notes.

Nilfisk S.p.A. a socio unico

Via Porrettana, 1991 – 41059 Zocca, (Modena) – Italy

Tel. +39 059 9730000 – Fax +39 059 9730065

industrial-vacuum@nilfisk.com

www.nilfisk.com

NILFISK